

ECS TUNING

Volkswagen MK7 Golf / Audi 8V A3

FWD and 4 Motion

Street Shield Skid Plate Installation

ECS TUNING
STREET SHIELD

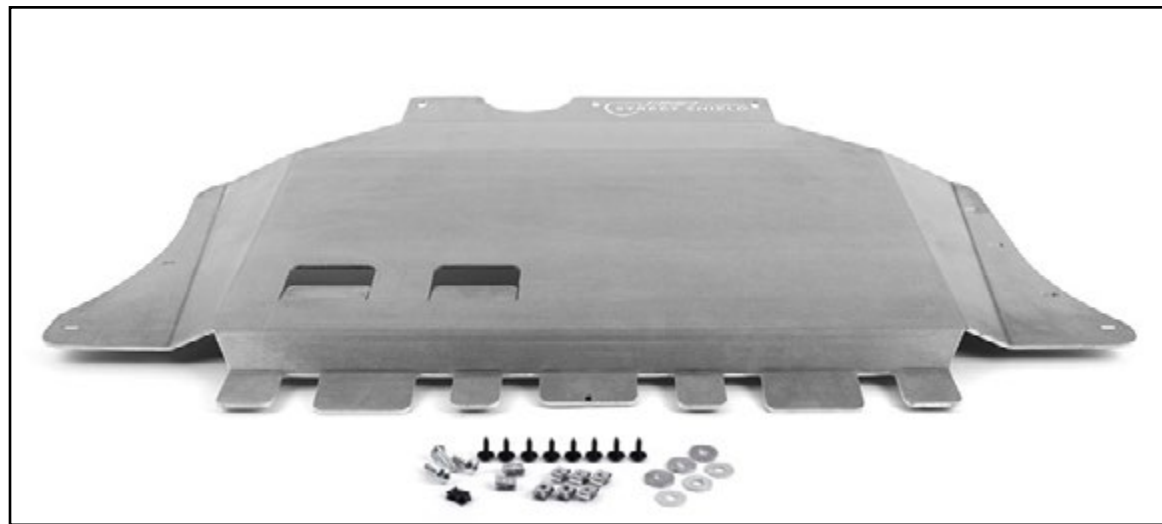





Proper service and repair procedures are vital to the safe, reliable operation of all motor vehicles as well as the personal safety of those performing the repairs. Standard safety procedures and precautions (including use of safety goggles and proper tools and equipment) should be followed at all times to eliminate the possibility of personal injury or improper service which could damage the vehicle or compromise its safety.

INTRODUCTION

The Project:

Today we're going to install our new Street Shield Skid Plate on our MK7 Volkswagen GTI. The fit and instructions are the same for the Audi 8V A3, and it fits FWD and 4-Motion models as well. This only requires a few basic tools, and will only take about 30 minutes of your time. We are installing it on a lift, but all you really need is a little extra room under the front so whether you support your car on jack stands or drive it up on ramps, you'll have plenty of room.

<p>EASY</p> 	<p>MODERATE</p> 	<p>ADVANCED</p> 	<p>PROFESSIONAL</p> 
<p>BASIC SKILLS REQUIRED</p>	<p>SOME EXPERIENCE RECOMMENDED</p>	<p>ADVANCED SKILLS & EXPERIENCE REQUIRED</p>	<p>PROFESSIONAL SKILLS & SPECIALTY TOOLS REQUIRED</p>

Here's all the tools you'll need:

1. Flat Blade Screwdriver
2. Pick
3. T25 Torx Driver
4. 5mm Allen



TABLE OF CONTENTS

Kit Contents.....	pg.4
Required Tools and Equipment.....	pg.5
Shop Supplies and Materials.....	pg.6
Installation and Safety Information.....	pg.7
Removing the Original Insulation Panel.....	pg.8
Installing the New Street Shield Skid Plate.....	pg.9
Schwaben Tools.....	pg.13

KIT CONTENTS



Mounting Screws (8)

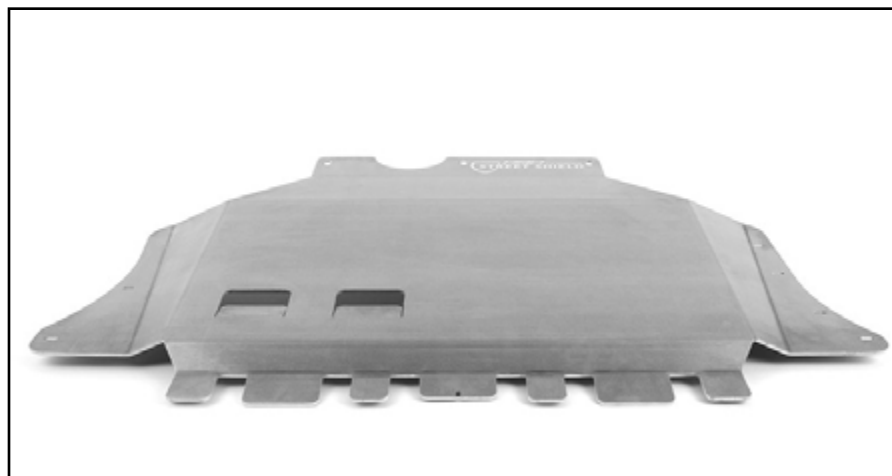

Street Shield Skid Plate

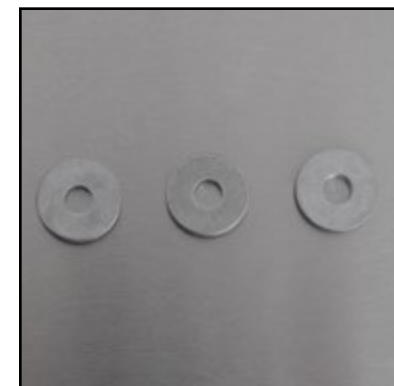

Rear Spacers (3)



Rear Mounting Bolts and Washers (3)

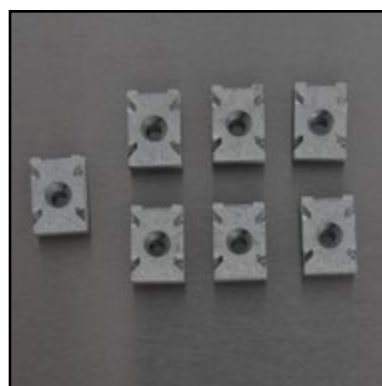

Side Wing Speed Nuts (7)



Front Speed Nut (1)

REQUIRED TOOLS

Note: The tools required for each step will be listed by the step number throughout these instructions.

Tool Recommendations: The following list of tools are part of a standard automotive tool set, and are used in various combinations for most automotive repairs. The tools required for this installation are **highlighted in red**, but we recommend you have this complete standard selection to overcome any issues that may arise such as rust, corrosion, or broken and stripped fasteners. The specific tools required for each step will be listed by the step number throughout these instructions, and any tools listed below with a **hyperlink** are available on our website.

- Protecta-Sockets (for lug nuts)..... [ES#2221243](#)
- 3/8" Drive Ratchet [ES#2765902](#)
- 3/8" Drive Torque Wrench..... [ES#2221245](#)
- 3/8" Drive Deep and Shallow Sockets [ES#2763772](#)
- 3/8" Drive Extensions [ES#2804822](#)
- Hydraulic Floor Jack [ES#240941](#)
- **Torx Drivers**..... [ES#11417](#)
- 1/2" Drive Deep and Shallow Sockets [ES#2839106](#)
- 1/2" Drive Ratchet
- 1/2" Drive Extensions
- 1/2" Drive Torque Wrench [ES#2221244](#)
- 1/2" Drive Breaker Bar [ES#2776653](#)
- Crows Foot Wrenches
- **Hook and Pick Tool Set**..... [ES#2778980](#)
- 1/4" Drive Ratchet [ES#2823235](#)
- 1/4" Drive Deep and Shallow Sockets..... [ES#2823235](#)
- 1/4" Drive Extensions [ES#2823235](#)
- Plier and Cutter Set..... [ES#2804496](#)
- **Flat and Phillips Screwdrivers** [ES#2225921](#)
- Jack Stands [ES#2763355](#)
- Ball Pein Hammers
- Pry Bar Set..... [ES#1899378](#)
- Bench Mounted Vise
- Punch and Chisel Set
- **Hex Bit (Allen) Wrenches and Sockets** [ES#11420](#)
- Thread Repair Tools [ES#1306824](#)
- Open/Boxed End Wrench Set [ES#2765907](#)

SHOP SUPPLIES AND MATERIALS

Standard Shop Supply Recommendations: We recommend that you have a standard inventory of automotive shop supplies before beginning this or any automotive repair procedure. The following list outlines the basic shop supplies that we like to keep on hand. Shop supplies with a hyperlink are available on our website.

- Hand Cleaner/Degreaser - [Click Here](#)
- Pig Mats - for protecting your garage floor and work area from spills and stains - [Click Here](#)
- Spray detailer - for rapid cleaning of anything that comes into contact with your paint such as brake fluid - [Click Here](#)
- Micro Fiber Towels - for cleaning the paint on your car - [Click Here](#)
- Latex Gloves - for the extra oily and dirty jobs - [Click Here](#)
- Medium and High Strength Loctite Thread lock compound - to prevent bolts from backing out - [Click Here](#)
- Anti-Seize Compound - to prevent seizing, galling, and corrosion of fasteners - [Click Here](#)
- Aerosol Brake/Parts Cleaner - for cleaning and degreasing parts
- Shop Rags - used for wiping hands, tools, and parts
- Penetrating oil - for helping to free rusted or stuck bolts and nuts
- Mechanics wire - for securing components out of the way
- Silicone spray lube - for rubber components such as exhaust hangers
- Paint Marker - for marking installation positions or bolts during a torquing sequence
- Plastic Wire Ties/Zip Ties - for routing and securing wiring harnesses or vacuum hoses
- Electrical tape - for wrapping wiring harnesses or temporary securing of small components

INSTALLATION NOTES

- **RH** refers to the passenger side of the vehicle.
- **LH** refers to the driver side of the vehicle.
- Always use the proper torque specifications.
- If applicable to this installation, torque specifications will be listed throughout the document and at the end as well.
- Please read all of these instructions and familiarize yourself with the complete process **BEFORE** you begin.

GENERAL PREPARATION AND SAFETY INFORMATION

ECS Tuning cares about your health and safety. Please read the following safety information. This information pertains to automotive service in general, and while it may not pertain to every job you do, please remember and share these important safety tips.

- Park your car in a safe, well lit, level area.
- Shut the engine off and remove the key from the ignition switch.
- Make sure any remote start devices are properly disabled.
- **ALWAYS** wear safety glasses.
- Make sure the parking brake is applied until the vehicle is safely lifted and supported.
- If using an automotive lift, be sure and utilize the factory specified lift points. Lifting a vehicle in an incorrect location can cause damage to the suspension/running gear.
- When lifting a vehicle using a jack, always utilize the factory specified lift points. Lifting a vehicle in an incorrect location can cause damage to the suspension/running gear. **ALWAYS** support the vehicle with jack stands.
- Always read and follow all safety information and warnings for the equipment you are using.



Never get underneath a vehicle that is supported only by a jack. Always make sure that the vehicle is securely supported on jack stands.

REMOVING THE ORIGINAL INSULATION PANEL

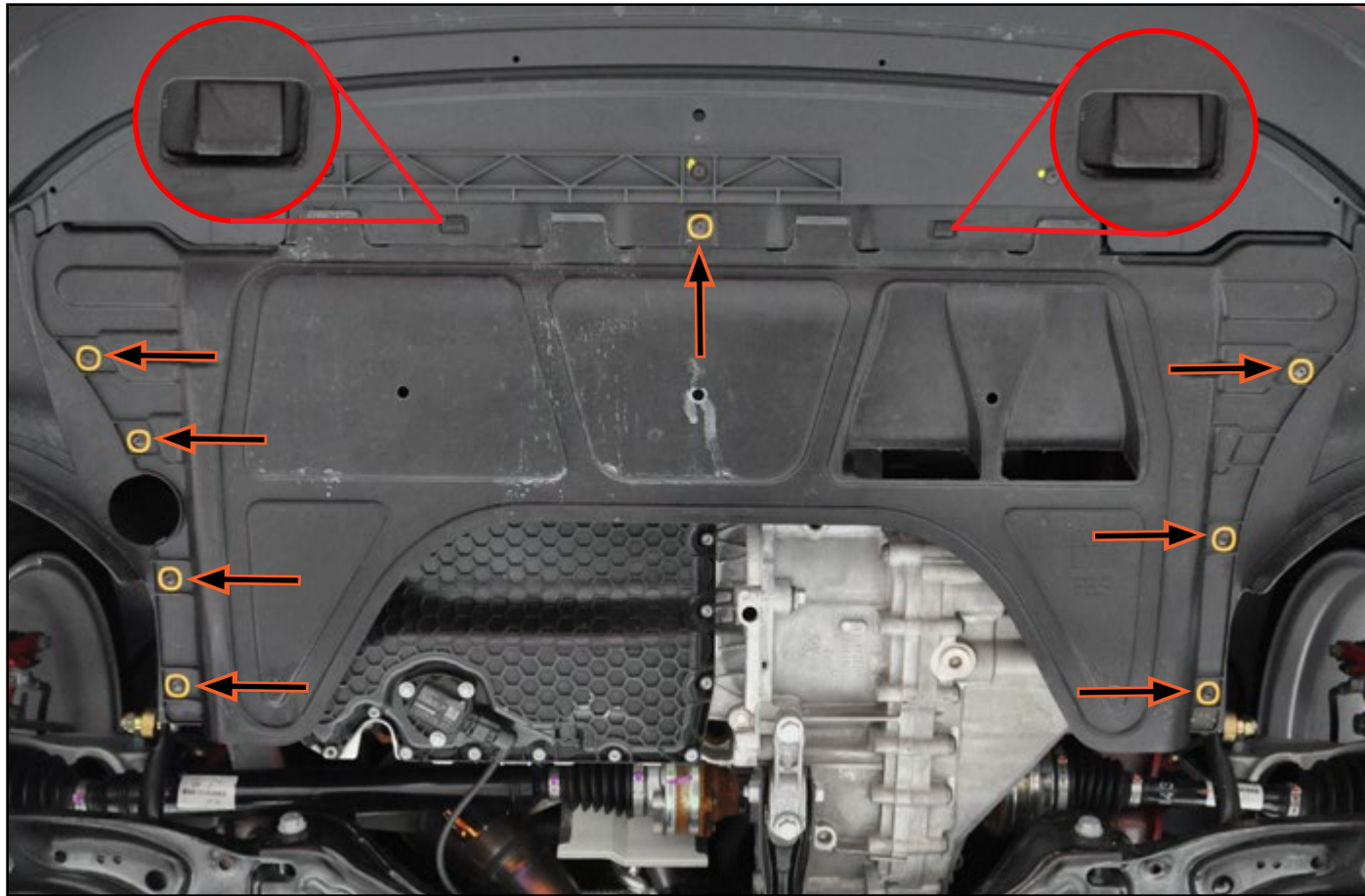

NOTE

Some vehicles may be equipped with full length insulation panels, which will include three additional mounting bolts at the rear.

To remove the original insulation panel, first remove the eight screws around the perimeter using a T25 Torx driver (see note). Next, release the two forward hooks using a flat blade screwdriver and pull the panel rearward to remove it.

INSTALLING THE NEW STREET SHIELD SKID PLATE

Step 1:

Locate the seven speed nuts on the side wings.

TECH TIP

To make this installation even easier, refer to the installed photo on [Page 12](#) at any time.

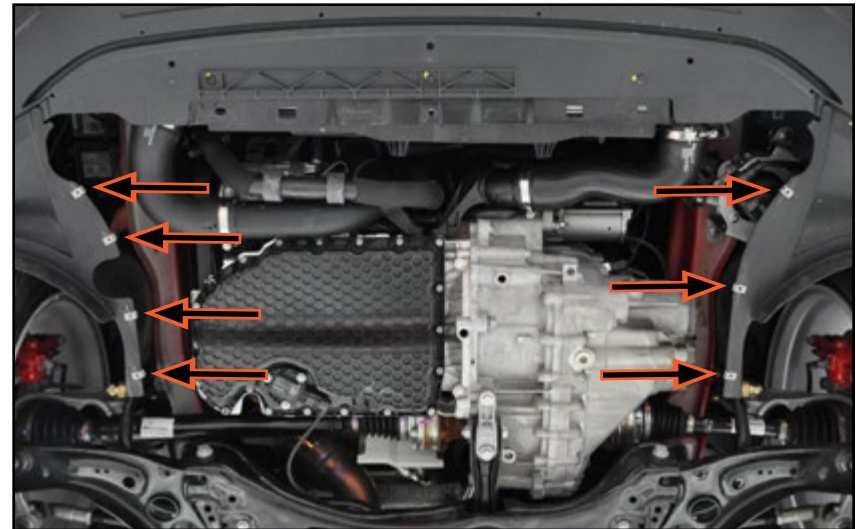

Step 2: Pick Tool

Pry them all off using a small pick or screwdriver and replace them with the new ones included in the kit.

NOTE

The side wing speed nuts and mounting screws are the same as the OE panel hardware. We include new ones with the kit since they are commonly worn out, but you may choose to reuse your original speed nuts and screws if they are in good condition.

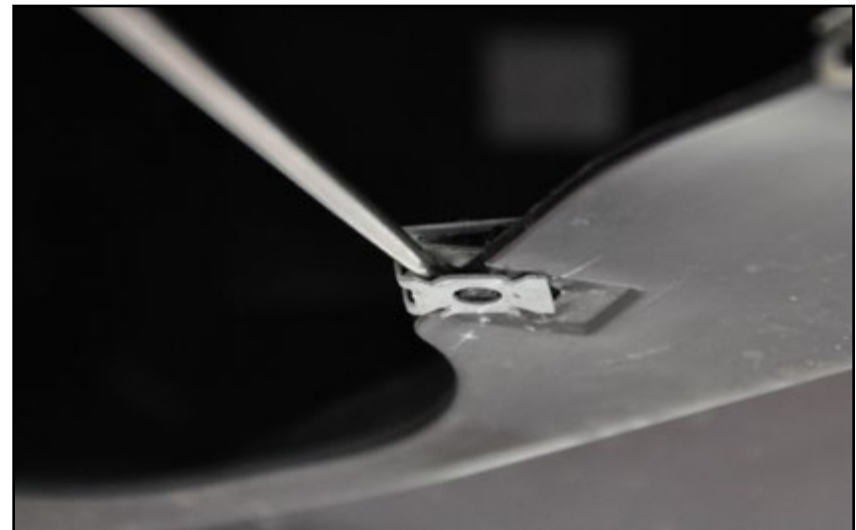

INSTALLING THE NEW STREET SHIELD SKID PLATE

Step 3:

Install the single Front Speed Nut onto the front center of the new Street Shield skid plate. Make sure the open hole is facing the bottom side of the Street Shield and the "threads" are on the top.

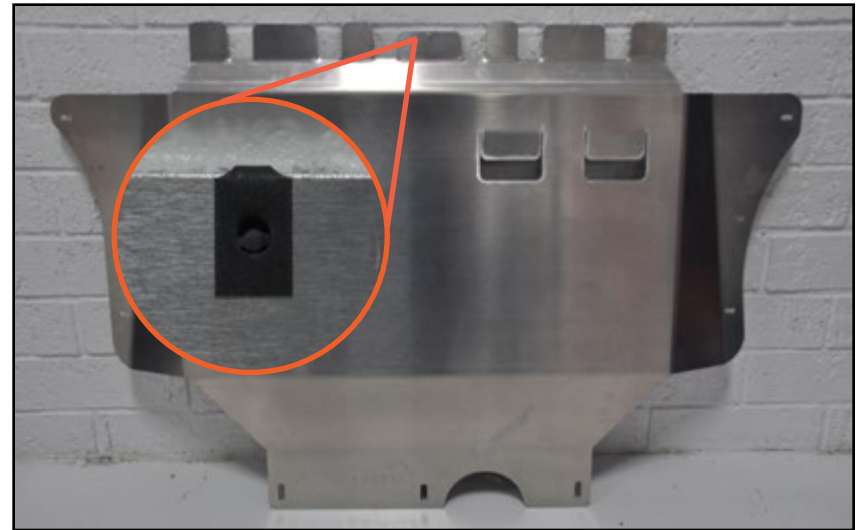

Step 4: T25 Torx

Slide the new skid plate into place, making sure the tabs on the front edge alternate and fit into the lower core support as shown. Thread one of the mounting screws into the front center to keep the skid plate from sliding backwards.

NOTE

Be sure to support the rear of the skid plate until the rear bolts are installed in the following steps so the full weight of it is not supported by the lower core support.

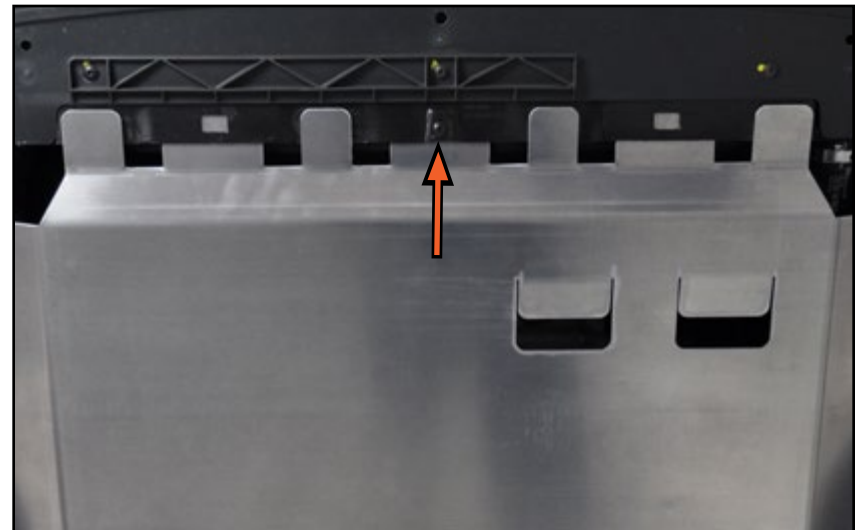

INSTALLING THE NEW STREET SHIELD SKID PLATE

Step 5:

Inspect the drawing on the right for the correct placement of the rear mounting hardware, then proceed with step 6.

NOTE

The washers and spacers may appear very similar, however you will be able to see upon inspection that the spacers are thicker than the washers.

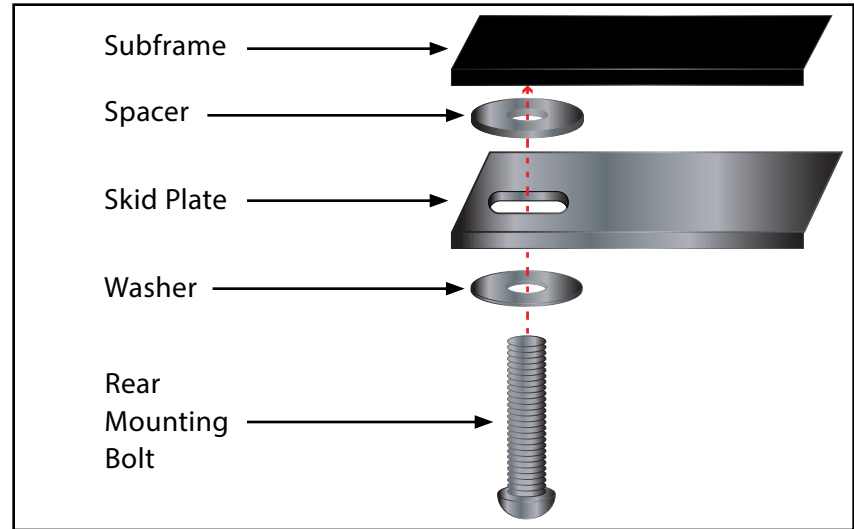

Step 6: 5mm Allen

Install the rear mounting bolts, washers, and spacers into the three rear mounting holes of the skid plate, making sure to place a washer onto each bolt and position the spacers between the skid plate and the subframe, as shown in step 5. Thread all of the bolts in loosely but do not tighten them at this time.

NOTE

It is not uncommon for the threads in the subframe to be rusty or corroded. If the bolts do not thread in easily, chase the threads in each hole prior to installing them.



INSTALLING THE NEW STREET SHIELD SKID PLATE



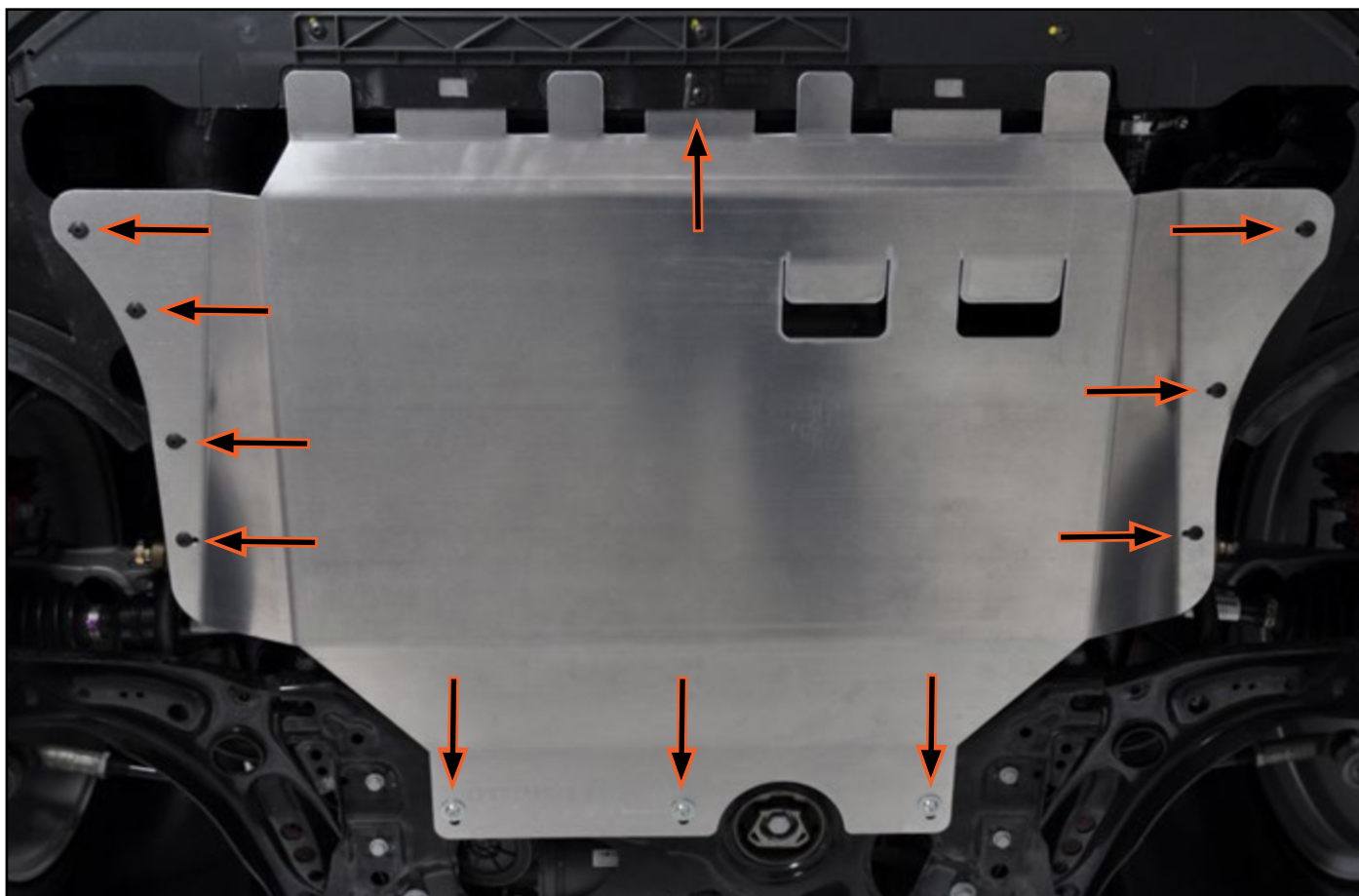

















Step 7:

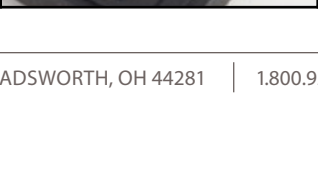
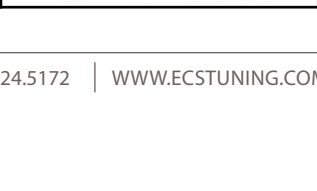

Install the seven remaining side wing screws, then tighten all eight Torx screws with a T25 Torx driver, and finally tighten the three rear mounting bolts using a 5mm Allen wrench or socket.

SCHWABEN - BUILD THE ULTIMATE TOOL COLLECTION

At ECS Tuning, we carry a line of high quality Schwaben Tools and Equipment to help you build your ultimate tool collection. Never before has affordability and quality been so closely related. Our entire Schwaben line is subjected to strict in house testing for strength and durability. See what we have to offer and equip your garage without breaking the bank.

					
	<u>Breaker Bar</u>	<u>Scraper, Hook, & Pick Set</u>	<u>Sockets</u>		
	<u>Creepers</u>	<u>Camshaft Tools</u>	<u>E-Drive Sockets</u>		
	<u>Gloves</u>	<u>Fan Clutch Wrenches</u>	<u>Car Ramps</u>		
	<u>Engine Bars</u>	<u>Tie Rod Tools</u>	<u>Torx Drivers</u>		
	<u>Screwdrivers</u>	<u>Brake Fluid Catch Bottle</u>	<u>Jack Stands</u>		
	<u>Pressure Bleeders</u>	<u>Tubing Cutter</u>	<u>Circuit Tester</u>		
	<u>Lighting</u>	<u>Booster Cables</u>	<u>Ratchets</u>		
	<u>Pry Bars</u>	<u>Oil Filter Tools</u>	<u>Exhaust Hanger Pliers</u>		
	<u>Coil Spring Compressors</u>	<u>Service Carts</u>	<u>Bubble Flaring Tool</u>		
	<u>Camber Gauge</u>	<u>Battery Charger</u>	<u>Thread Chaser</u>		
	<u>Hose Pinch Pliers</u>	<u>Stethoscope</u>	<u>Drain Pans</u>		
	<u>Wheel Bolt Pattern Gauge</u>	<u>Battery Terminal Brush</u>	<u>Wrenches</u>		
	<u>Ball Joint Separator</u>	<u>Wheel Chocks</u>	<u>Impact Sockets</u>		
	<u>Vanos Solenoid Socket</u>	<u>Torx Sockets</u>	<u>Torque Wrenches</u>		
					
					

Your Street Shield Skid Plate Installation is complete!

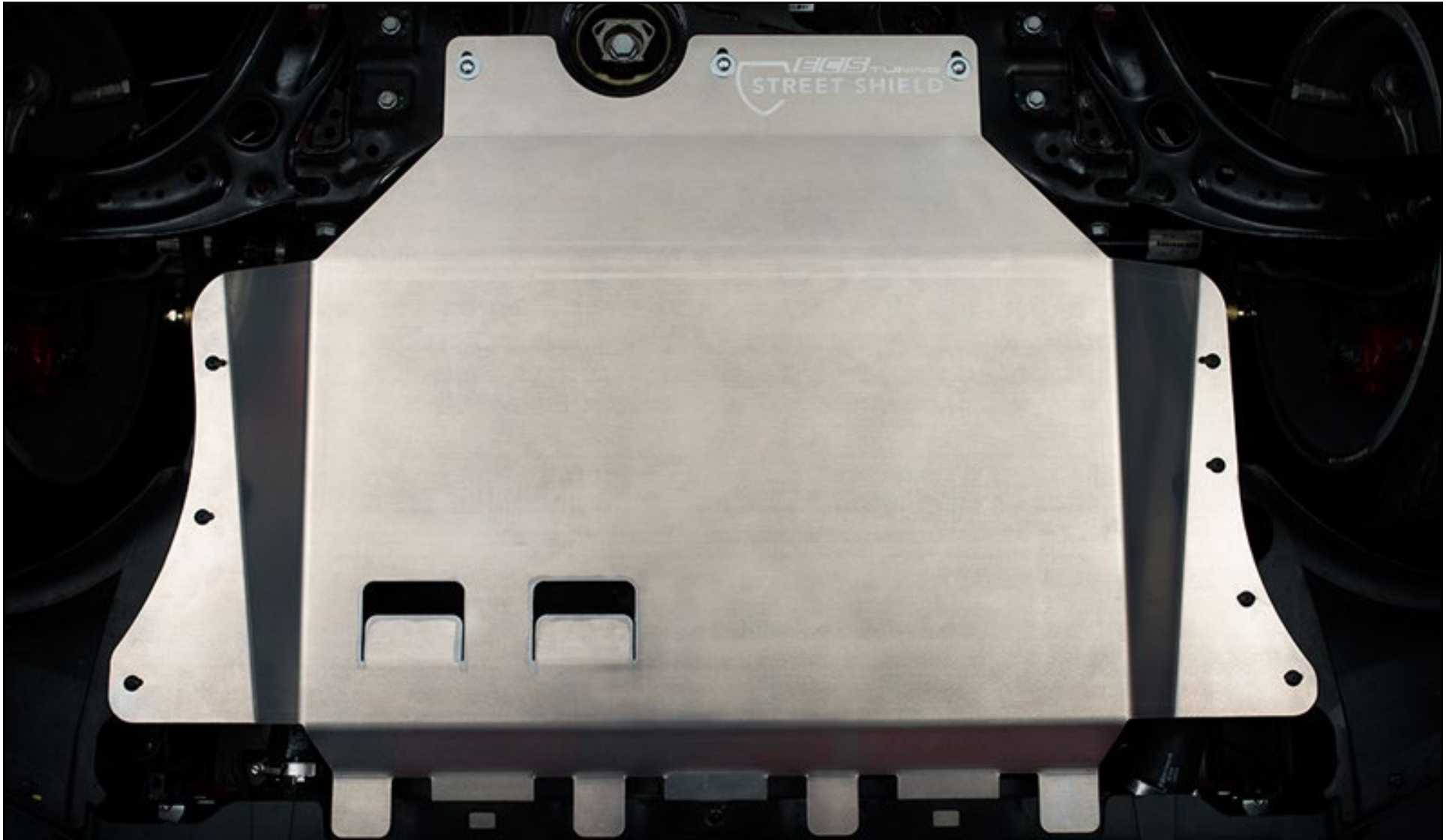

These instructions are provided as a courtesy by ECS Tuning

Proper service and repair procedures are vital to the safe, reliable operation of all motor vehicles as well as the personal safety of those performing the repairs. Standard safety procedures and precautions (including use of safety goggles and proper tools and equipment) should be followed at all times to eliminate the possibility of personal injury or improper service which could damage the vehicle or compromise its safety.

Although this material has been prepared with the intent to provide reliable information, no warranty (express or implied) is made as to its accuracy or completeness. Neither is any liability assumed for loss or damage resulting from reliance on this material. SPECIFICALLY, NO WARRANTY OF MERCHANTABILITY, FITNESS FOR A PARTICULAR PURPOSE OR ANY OTHER WARRANTY IS MADE OR TO BE IMPLIED WITH RESPECT TO THIS MATERIAL. In no event will ECS Tuning, Incorporated or its affiliates be liable for any damages, direct or indirect, consequential or compensatory, arising out of the use of this material.