

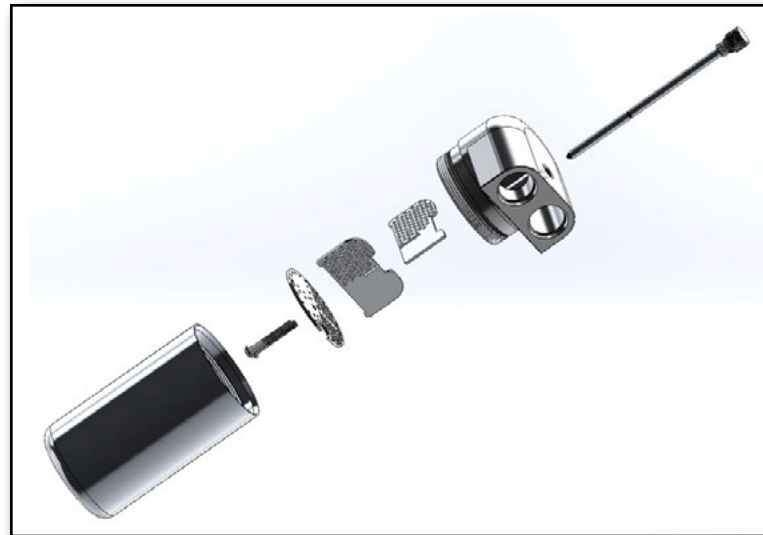

Volkswagen MK7 Golf R Catch Can System Installation Instructions



Skill Level 1
- Easy -
Basic Skills
Required



Proper service and repair procedures are vital to the safe, reliable operation of all motor vehicles as well as the personal safety of those performing the repairs. Standard safety procedures and precautions (including use of safety goggles and proper tools and equipment) should be followed at all times to eliminate the possibility of personal injury or improper service which could damage the vehicle or compromise its safety.

INTRODUCTION

ECS Tuning Catch Can System

Today's direct fuel injection systems have taken engine performance to a whole new level, but there is a drawback. With no fuel vapors to clean the intake valves, the oil vapors that are drawn into the intake from the PCV system will deposit themselves onto the valves and intake ports. Over time, this will result in an excessive carbon buildup, resulting in lost power and poor driveability. At ECS Tuning, we have taken our already successful catch can and designed a kit specifically for your VW MK7 Golf R. While the original crankcase ventilation system on your car is very well designed and has built in oil separation, there are still fine oil vapors that get through. The baffled construction and engineered flow of our catch can will separate and store these vapors in an easy to clean remote mount reservoir.

Installing one of our catch can systems is an easy project, and we're going to take you through the entire process step by step so your install can go smoothly and quickly. The end result is a functional system with a great factory like appearance that you'll be proud to show off! Thank you for looking to ECS Tuning for all your performance and repair needs, we appreciate your business!

TABLE OF CONTENTS

Kit Contents	pg.3
Required Tools and Equipment	pg.4
Installation and Safety Information	pg.5
Installing the Catch Can System	pg.6
Cleaning and Maintenance	pg.22
Cold Weather Operation	pg.27
Reversing the Flow of the Catch Can	pg.28

KIT CONTENTS

Catch Can w/Dipstick and Allen Wrench



Turbo Inlet Adapter Fitting and Clip



PCV Adapter Fitting, Top Plate, Screws, and Seal



Catch Can Mounting Bracket



Feed and Return Hose Assembly



Hose Locating Clip and Billet Hose Separator



Loctite



Feed Hose Spacer and Seal

REQUIRED TOOLS

Note: The tools required for each step will be listed by the step number throughout these instructions.

Standard Automotive Tools

- Protecta-Sockets (for lug nuts)..... [ES#2221243](#)
- **3/8" Drive Ratchet**..... [ES#2765902](#)
- 3/8" Drive Torque Wrench..... [ES#2221245](#)
- 3/8" Drive Deep and Shallow Sockets..... [ES#2763772](#)
- 3/8" Drive Extensions [ES#2804822](#)
- Hydraulic Floor Jack [ES#2834951](#)
- **Torx Drivers and Sockets** [ES#11417/8](#)
- 1/2" Drive Deep and Shallow Sockets..... [ES#2839106](#)
- 1/2" Drive Ratchet
- 1/2" Drive Extensions
- 1/2" Drive Torque Wrench..... [ES#2221244](#)
- 1/2" Drive Breaker Bar [ES#2776653](#)
- Bench Mounted Vise
- Crows Foot Wrenches
- Hook and Pick Tool Set [ES#2778980](#)

Required For This Install

- **1/4" Drive Ratchet**..... [ES#2823235](#)
- **1/4" Drive Deep and Shallow Sockets**..... [ES#2823235](#)
- **1/4" Drive Extensions**..... [ES#2823235](#)
- Plier and Cutter Set..... [ES#2804496](#)
- **Flat and Phillips Screwdrivers** [ES#2225921](#)
- Jack Stands [ES#2763355](#)
- Ball Pein Hammers
- Pry Bar Set..... [ES#1899378](#)
- Electric/Cordless Drill
- Wire Strippers/Crimpers
- **Adjustable (Crescent) Type Wrenches**
- Punch and Chisel Set
- **Hex Bit (Allen) Wrenches and Sockets** [ES#11420](#)
- Thread Repair Tools [ES#1306824](#)
- Open/Boxed End Wrench Set [ES#2765907](#)

Available On Our Website

Specialty Tools

- **Locking Hose Clamp Pliers**..... [ES#2702616](#)

INSTALLATION NOTES

- **RH** refers to the *passenger side* of the vehicle.
- **LH** refers to the *driver side* of the vehicle.
- Always use the proper torque specifications.
- If applicable to this installation, torque specifications will be listed throughout the document and at the end as well.
- Please read all of these instructions and familiarize yourself with the complete process **BEFORE** you begin.

GENERAL PREPARATION AND SAFETY INFORMATION

ECS Tuning cares about your health and safety, please read the following safety information. This information pertains to automotive service in general, and while it may not pertain to every job you do, please remember and share these important safety tips.

- Park your car in a safe, well lit, level area.
- Shut the engine off and remove the key from the ignition switch.
- Make sure any remote start devices are properly disabled.
- **ALWAYS** wear safety glasses.
- Make sure the parking brake is applied until the vehicle is safely lifted and supported.
- Whether lifting a vehicle using an automotive lift or a hydraulic jack, be sure and utilize the factory specified lift points.
- Lifting a vehicle in an incorrect location can cause damage to the suspension/running gear.
- **ALWAYS** support the vehicle with jack stands.
- **ALWAYS** read and follow all safety information and warnings for the equipment you are using.



NEVER get underneath a vehicle that is supported only by a jack, and **ALWAYS** make sure that the vehicle is securely supported on jack stands.

INSTALLING THE CATCH CAN SYSTEM

Here is an overview of the MK7 Golf R engine compartment. As you can see, the catch can will be mounted on the front RH (passenger's) side just behind the headlight.

Take a look at the photo below and familiarize yourself with the mounting location and hose routing for this system. It's important to note that the catch can system needs to be setup in **STANDARD FLOW**. Be sure to confirm that your catch can is set up for standard flow **BEFORE** connecting the hoses (see inset photo below).

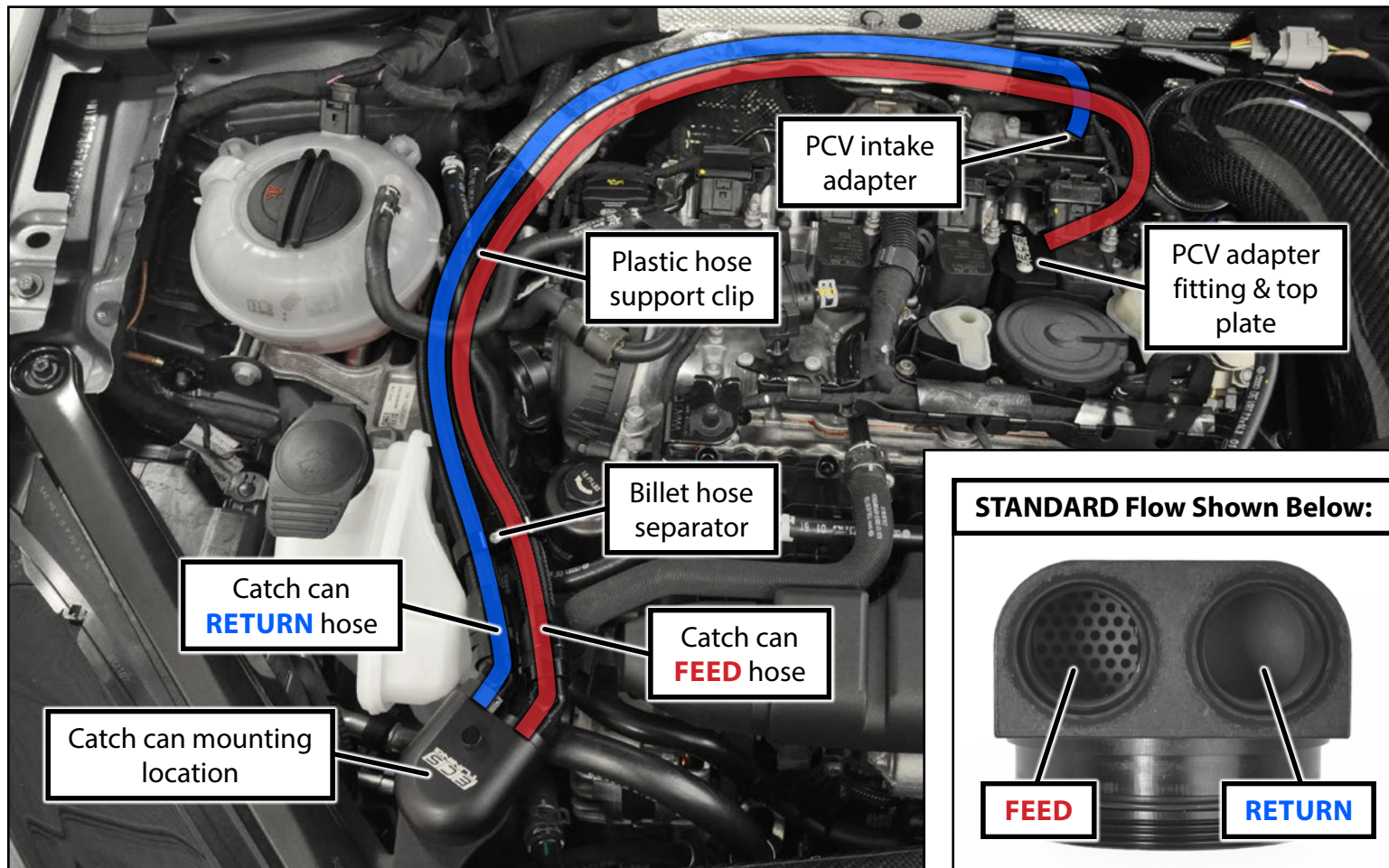

INSTALLING THE CATCH CAN SYSTEM

Step 1: T30 Torx

Remove the two screws holding the diagonal brace to the radiator core support.

Also note the position of the clamp on the coolant bypass hose (highlighted in **GREEN**). In some cases, the hose clamp will be installed off center and facing towards the RH side of the car. This would interfere with the catch can once it's installed. If the clamp on your car is off to the side simply loosen it and rotate until it faces upward.

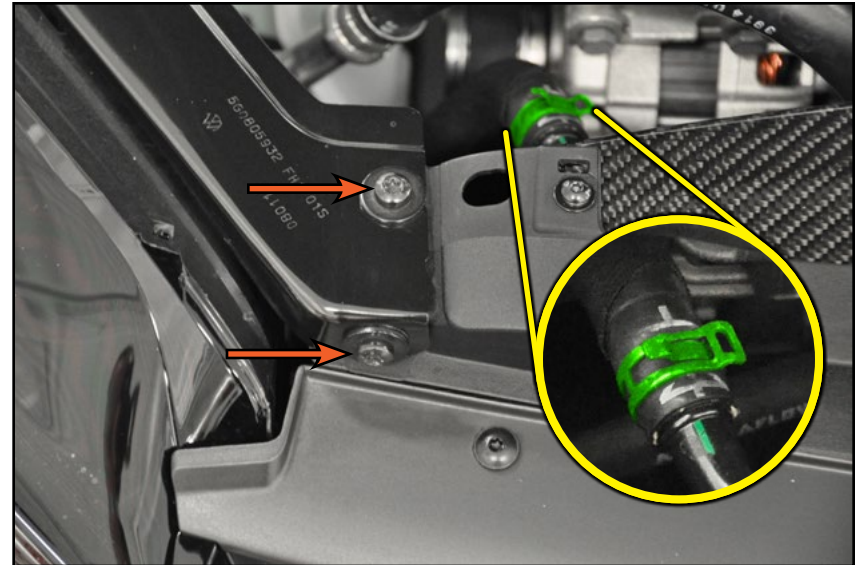

Step 2:

If you haven't done so already, now is the time to confirm that the catch can is set up for **STANDARD FLOW** (shown in the photo on the right).



If your catch can is not set up for **STANDARD FLOW**, please click [HERE](#) to jump ahead to our instructions on reversing the flow of your catch can.

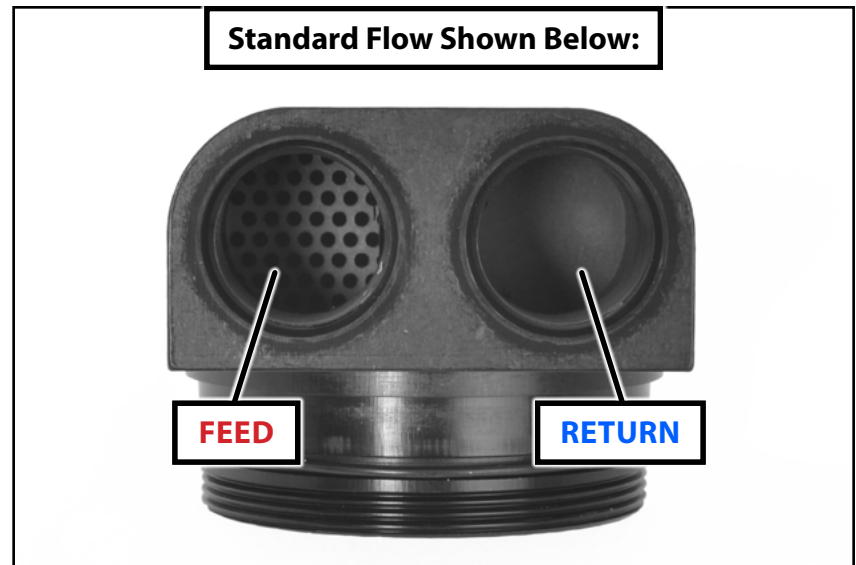

INSTALLING THE CATCH CAN SYSTEM

Step 3: T30 Torx

Install the catch can separator into the bracket by doing the following:

- Unthread the catch can reservoir **and** remove the O-ring from the catch can separator.
- Place the separator into the bracket.
- Lubricate the O-ring with clean engine oil, then install it into the groove in the separator.
- Thread the reservoir onto the separator, but leave it loose at this time (shown in the LH photo). We'll need to swivel the separator around later on in the install.
- Install the entire assembly into the vehicle using the bolts we removed during step 1 (shown in the RH photo).



Step 4:

Remove the engine cover by pulling up at the four corners.



INSTALLING THE CATCH CAN SYSTEM

Step 5: 10mm Socket & Ratchet

Underneath the engine cover, you'll see the four ignition coils. Locate the coil pack for cylinder #4 (the coil pack which is closest to the LH side of the engine).

Remove the nut securing the ground wire to the coil mounting bolt, then lift off the ground wire.

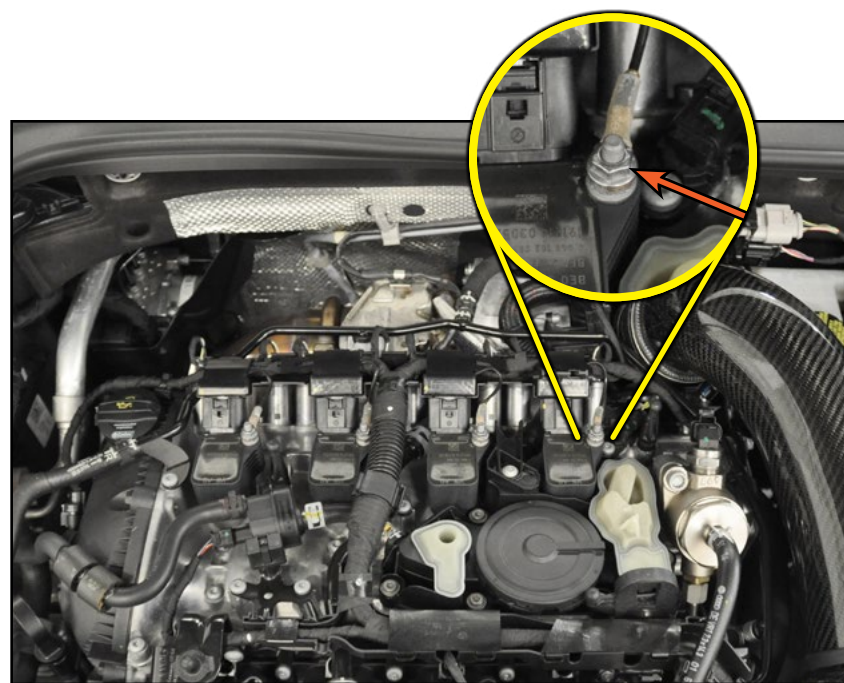

Step 6:

Push in the release tab on all four ignition coil electrical connectors, then pull each one up slightly so they remain released from the coils.

Push the coil harness back gently so all four connectors slide off the coils by approximately $\frac{1}{2}$ ". It is not necessary to completely remove the connectors.

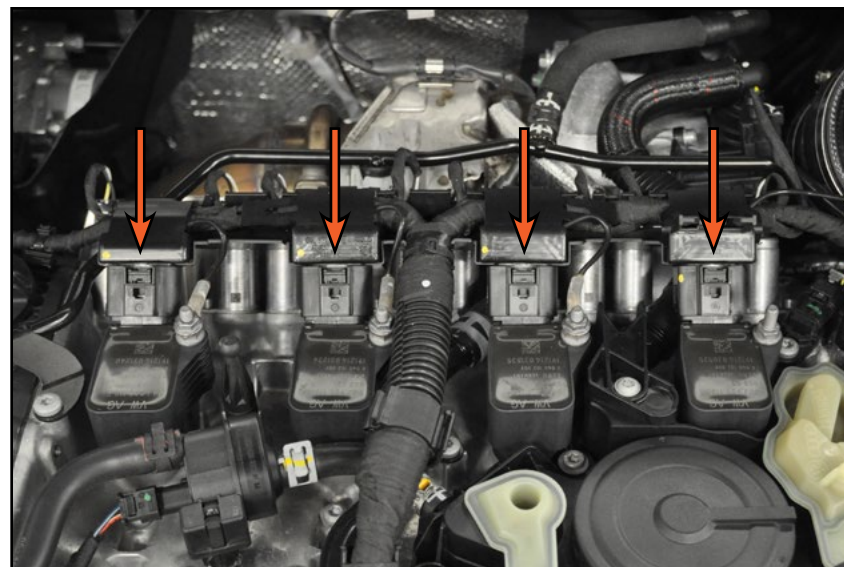

INSTALLING THE CATCH CAN SYSTEM

Step 7:

Remove the mounting bolt for coil #4. Push the electrical connector off of coil #4 and remove the coil by pulling it straight up. You may have to pull fairly hard until the boot releases from the spark plug.



Step 8: T30 Torx

Remove the screw which secures the OE vent hose to the PCV assembly on top of the valve cover.

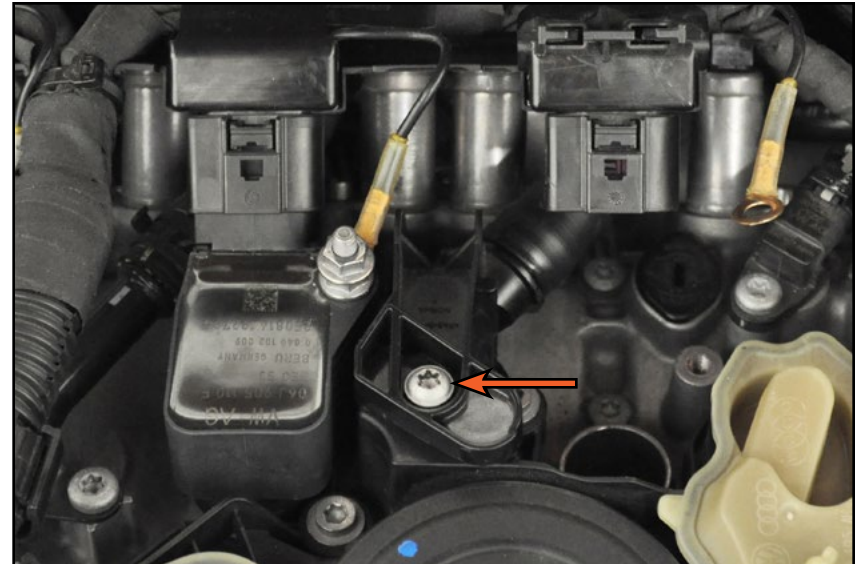

INSTALLING THE CATCH CAN SYSTEM

Step 9:

Removing the OE vent hose from the valve cover is a little tricky. Use a flashlight and look down on the back side of the hose end, you will see that it is held in place by a small retaining tab underneath. This tab needs to be gently pushed downward to release the hose from the PCV assembly, then the front of the hose needs to be lifted slightly while also pulling the hose out of the PCV.

Use the illustrations on the right as a reference while proceeding to the next page.

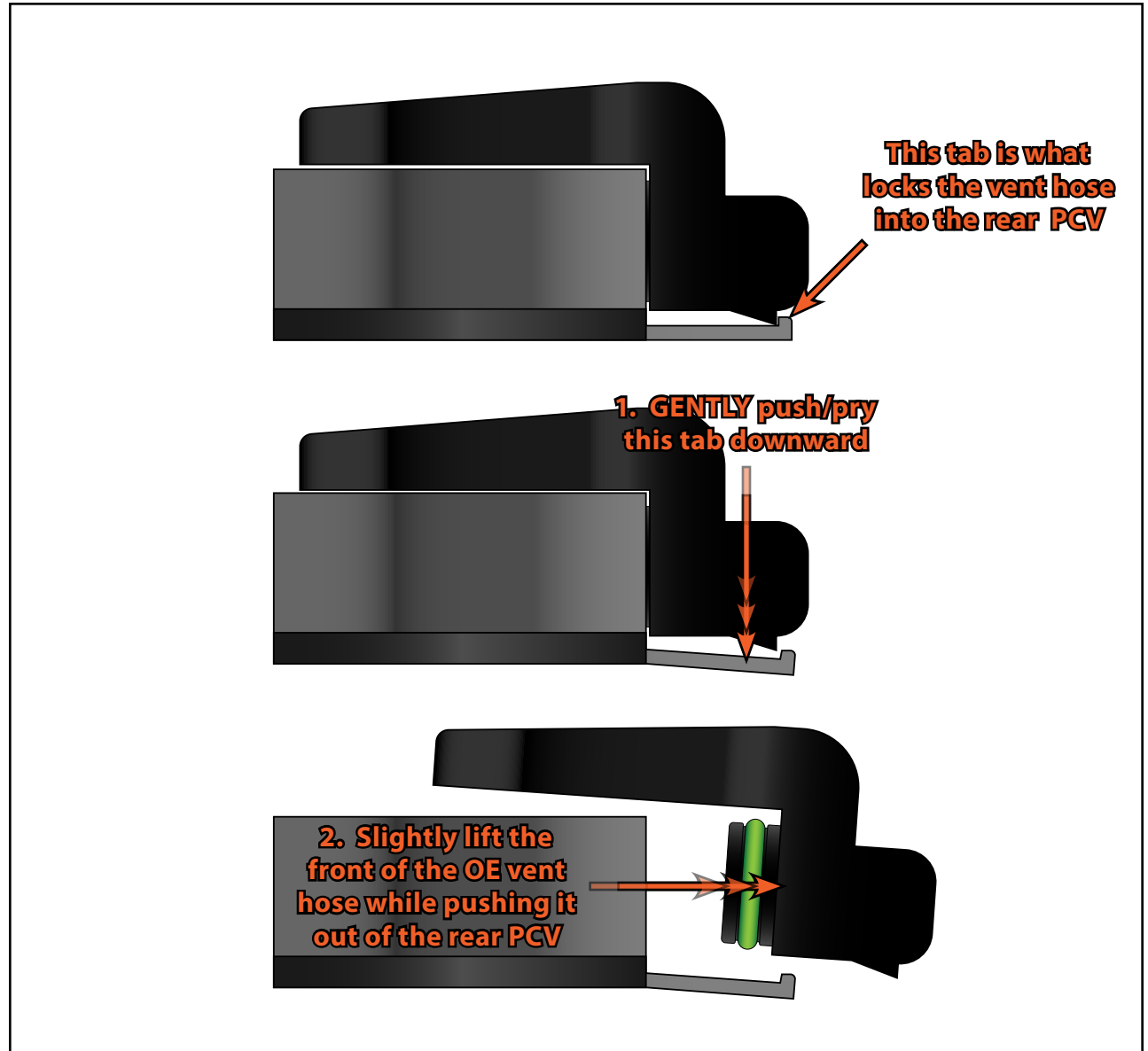

INSTALLING THE CATCH CAN SYSTEM

Step 10: Flat Blade Screwdriver

Using the outline from the previous page as a guide, gently pry down on the clip which secures the OE vent hose to the PCV assembly, then lift the front of the hose slightly while you push the hose out of the PCV.

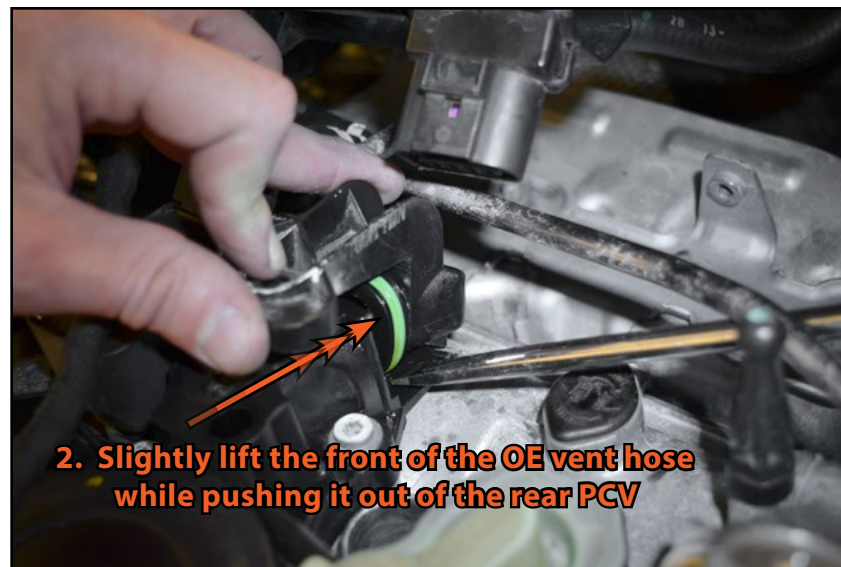

INSTALLING THE CATCH CAN SYSTEM

Step 11:

Now remove the crank vent hose (highlighted in **GREEN**) from the turbo inlet. This hose has an internal expanding snap ring that holds it in place. Grip the end, pull upward, and rock the hose back and forth until it releases from the barb on the turbo inlet.

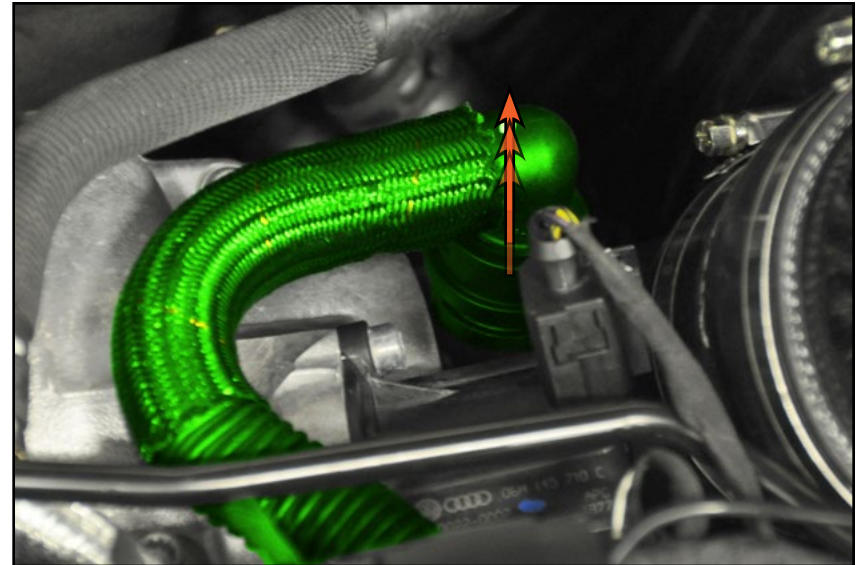

Step 12:

With the crank vent hose released from both ends, begin to rotate it upside down.

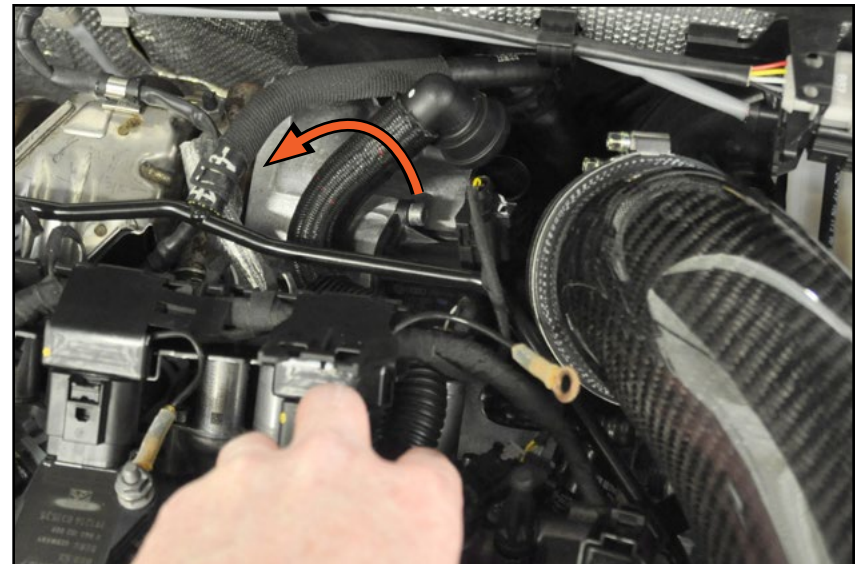

INSTALLING THE CATCH CAN SYSTEM

Step 13:

Continue to rotate the hose upside down and carefully guide it out underneath the coolant air bleed line.



Step 14:

Lubricate the o-ring with clean engine oil, then push the new ECS PCV adapter fitting into the back of the original oil separator. You will have to firmly push in on the lower back corner until it snaps in place and is held on by the two retaining tabs.



INSTALLING THE CATCH CAN SYSTEM

Step 15:

Place the o-ring into the groove in the PCV adapter fitting top plate. Use a small amount of clean engine oil to hold it in place.

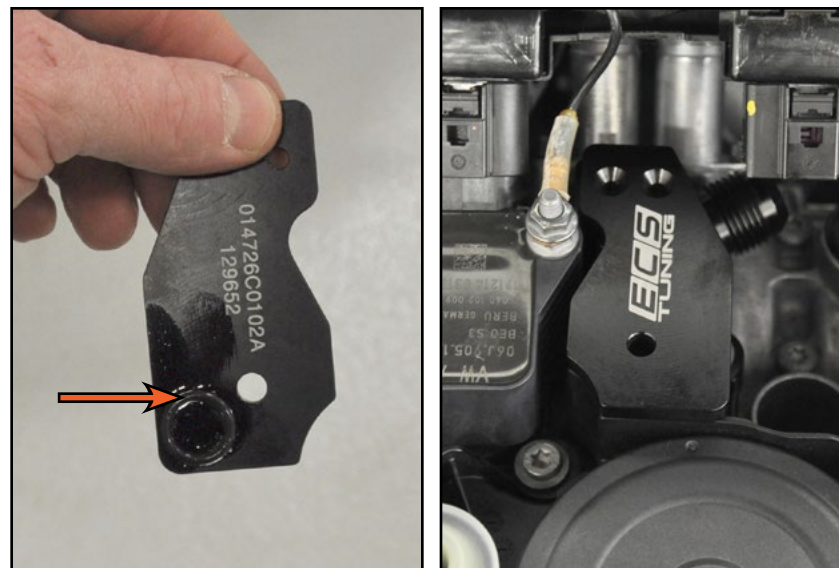

Step 16: 2.5mm Allen Wrench, T30 Torx

Set the PCV adapter fitting top plate into place with the two beveled holes lined up over the screw holes in the PCV adapter fitting, making sure the o-ring stays in place.

Place a single drop of the included **BLUE** Loctite onto each of the screws, then install them into the PCV assembly **BY HAND**, and tighten them to until they make contact + 1/8 turn.

Reinstall the crank vent hose mounting screw (arrow).

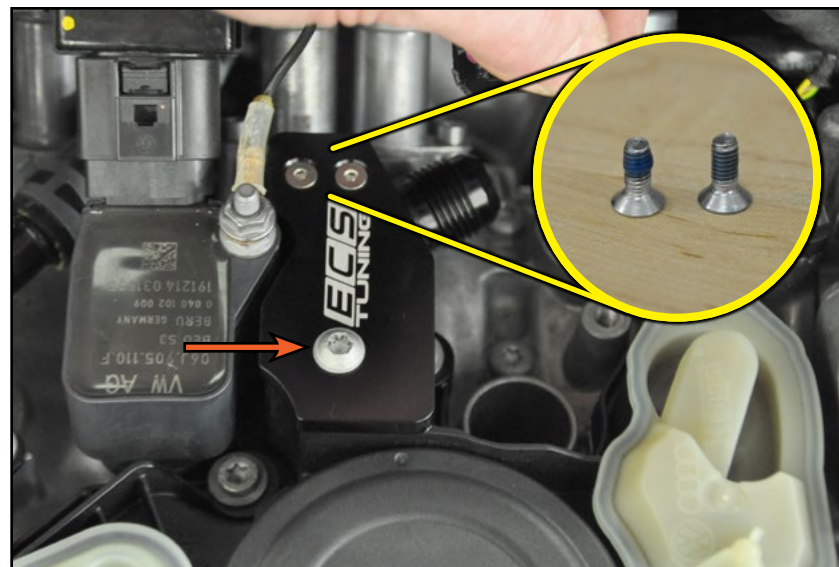

INSTALLING THE CATCH CAN SYSTEM

Step 17: AN Fitting Wrenches - or - Crescent Wrenches

Unpack the catch can hose set, then install the rear turbo inlet adapter fitting onto the 90° end of the return hose (the feed hose has straight fittings on both ends). Once the fitting is snug, it is only necessary to tighten it a few additional degrees.

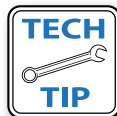

AN fitting wrenches are designed specifically to tighten these without damaging the fitting or the finish. Using them carefully, crescent type wrenches will also do the job but it's best to apply masking tape to the fitting before tightening to protect the finish.



Step 18:

Now it's time to position the hoses in their approximate location in the car.

Route the hoses so the 90° fitting of the return is located near the turbo inlet, and the opposite ends are near the catch can. Make sure they run parallel with the firewall, then underneath the coolant hoses near the coolant reservoir.

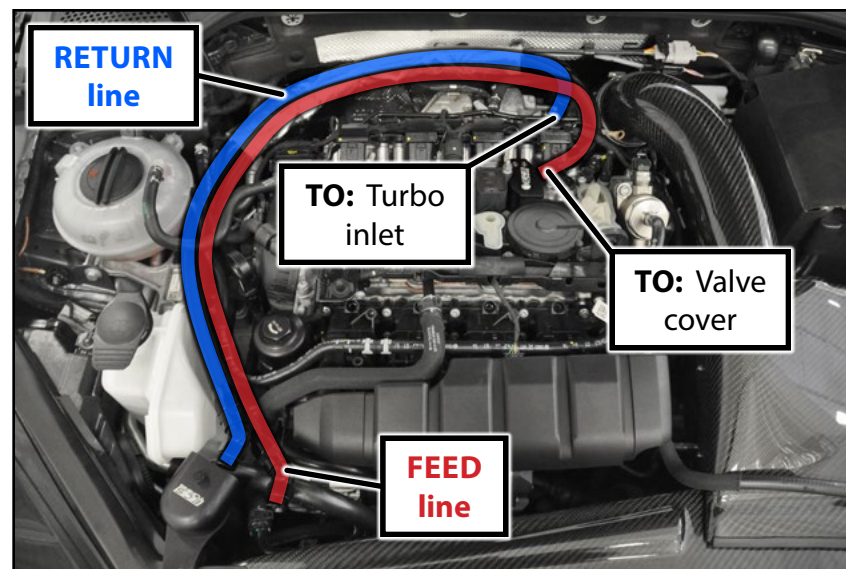

INSTALLING THE CATCH CAN SYSTEM

Step 19:

Push the turbo inlet fitting (on the end of the 90° return hose) down onto the turbo inlet barb. Install the metal retaining clip into the groove in the fitting.

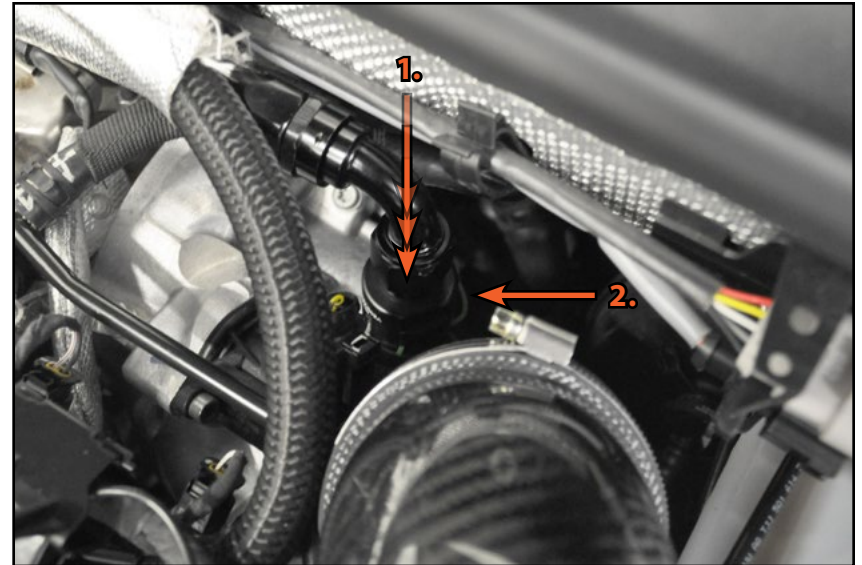

Step 20: AN Fitting Wrench - or - Crescent Wrench

Make sure the feed hose runs underneath the ignition coil harness, then thread it onto the PCV adapter fitting and tighten it.



INSTALLING THE CATCH CAN SYSTEM

Step 21: 10mm Socket & Ratchet

Reinstall the #4 coil and the ground wire, then push all four coil electrical connectors onto the coils until they are fully seated. You will hear an audible “click” when each connector locks in place.

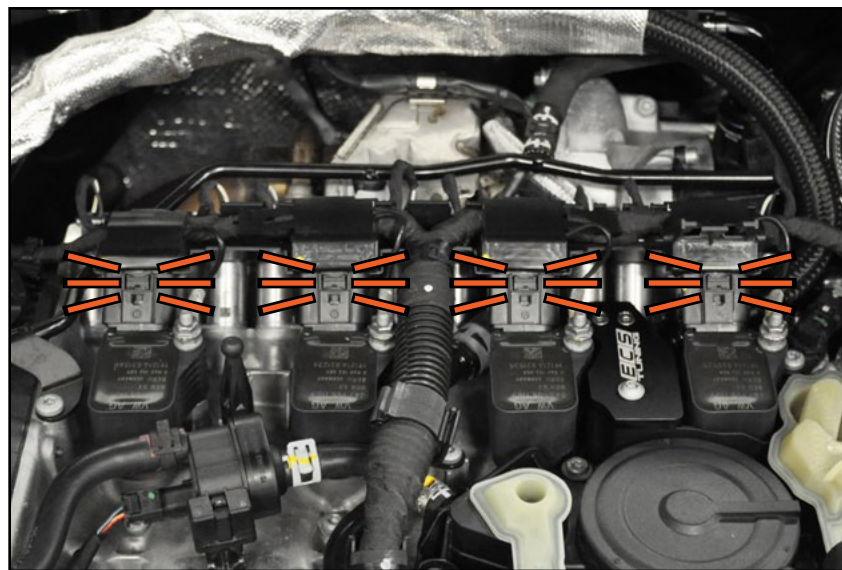

Step 22:

Double check and make sure the hoses run underneath the coolant and fuel lines on the RH side of the engine. Make sure that no lines are tangled, kinked, or pinched.



INSTALLING THE CATCH CAN SYSTEM

Step 23: AN Fitting Wrench - or - Crescent Wrench

Follow the hoses from the turbo inlet and valve cover so you can identify their position at the catch can.

- The **FEED** hose runs from the adapter on the back of the valve cover to the **FEED** side of the catch can.
- The **RETURN** hose runs from the turbo inlet adapter to the **RETURN** side of the catch can.

Connect and tighten the **RETURN** hose to the catch can separator.



Step 24:

Lubricate the o-ring with clean engine oil, then install it onto the feed hose spacer. Install the spacer onto the end of the **FEED** hose, making sure that the o-ring is facing toward the catch can separator.



INSTALLING THE CATCH CAN SYSTEM

Step 25: AN Fitting Wrench - or - Crescent Wrench

Connect and tighten the **FEED** hose to the catch can separator.

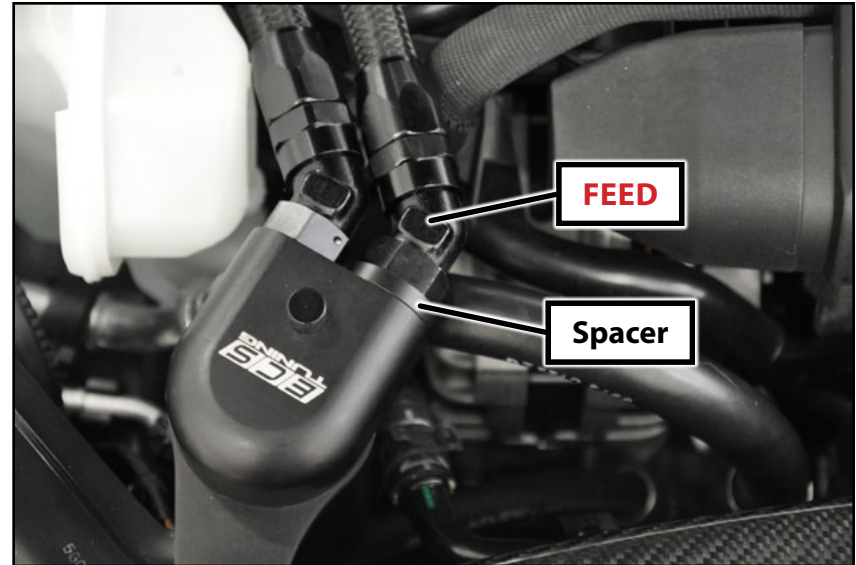

Step 26:

Tighten the catch can reservoir to lock the catch can in place in the mounting bracket.



INSTALLING THE CATCH CAN SYSTEM

Step 27:

Install the line separator near the front of the hoses. Clip the line support into place between the A/C line and hoses.

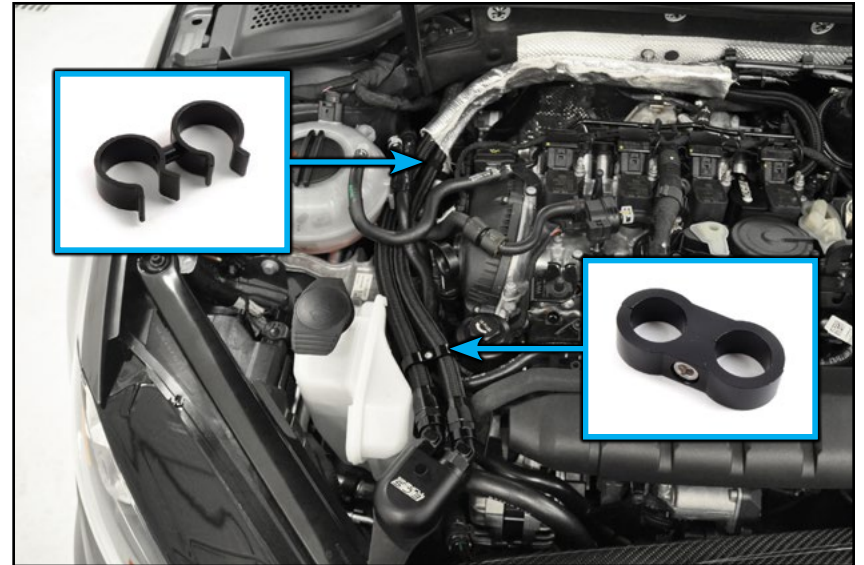

Step 28:

Confirm that the hoses are properly routed, roll the seam of the heat shield so it is located underneath the hoses (for best appearance), and reinstall the engine cover.

Your Catch Can installation is complete!



CLEANING AND MAINTENANCE

Step 1:

We recommend that you check the level of the waste in your catch can on a regular basis. Start with once a week until you determine the amount of time it takes your car to fill the reservoir.

Note that all MK7 catch can kits come with an 8oz reservoir. The dipstick will not reach all the way to the bottom of the reservoir, so the dipstick won't register all of the build up inside.

Empty and clean the reservoir when the waste registers approximately 2" up on the dipstick.

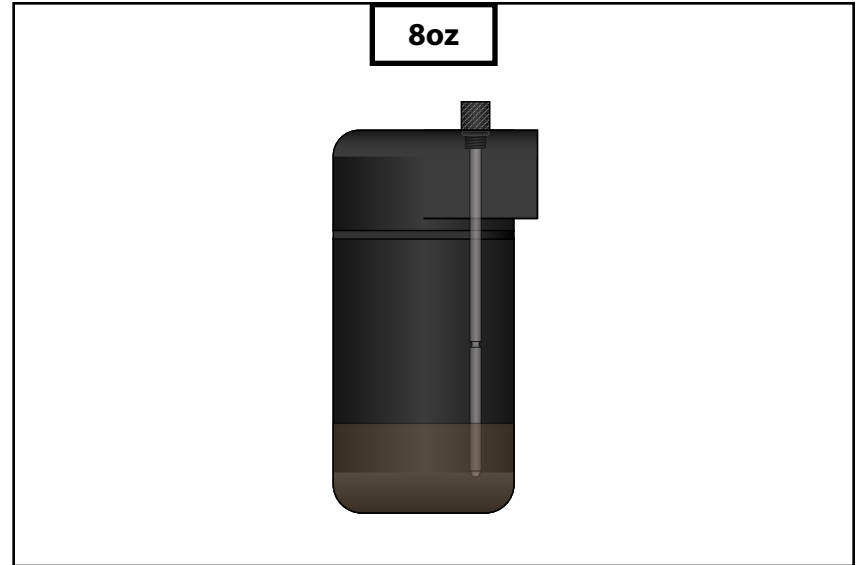

Step 2:

About twice a year, we recommend that you remove the separator for cleaning. To remove it, unthread the reservoir, disconnect the lines, remove the o-ring seal and lift the separator out of the bracket.



If the o-ring seal needs to be replaced, it is available as a replacement part on our website: [ES#3097721](#).

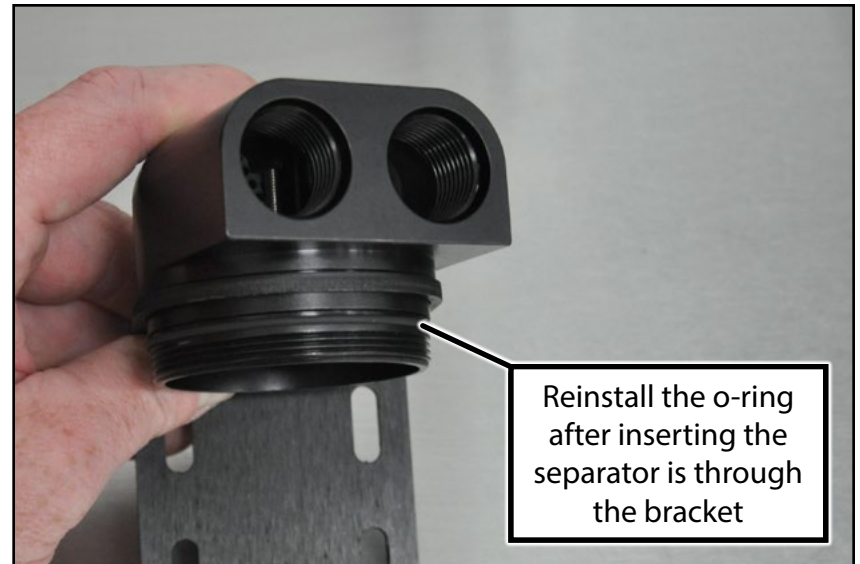

CLEANING AND MAINTENANCE

Step 3:

Once you have removed the separator, note the orientation of the baffle inside. The feed side of the separator has a number of small holes in it, the return side looks like a flat plate.

Step 4:

Using the 2.5mm allen wrench included with the kit, remove the two baffle plate screws.

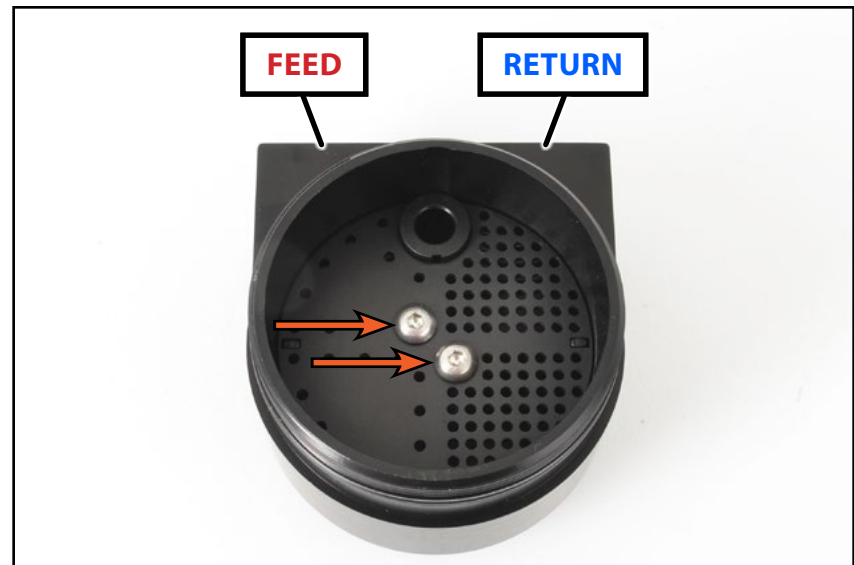
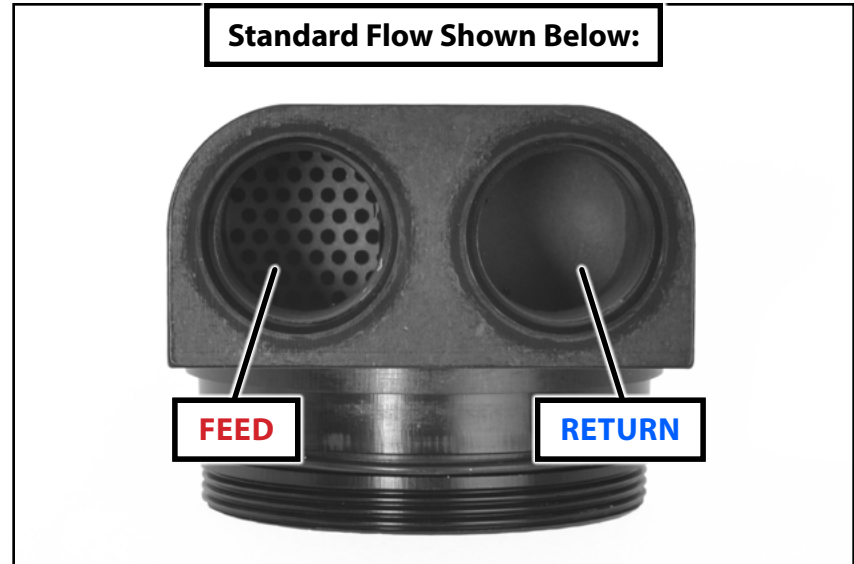

CLEANING AND MAINTENANCE

Step 5:

Lift the baffle plate out of the separator housing.



Step 6:

Lift the remaining baffles out of the separator housing.



CLEANING AND MAINTENANCE

Step 7:

Note the positions of the fixed baffle and the reversing baffle.

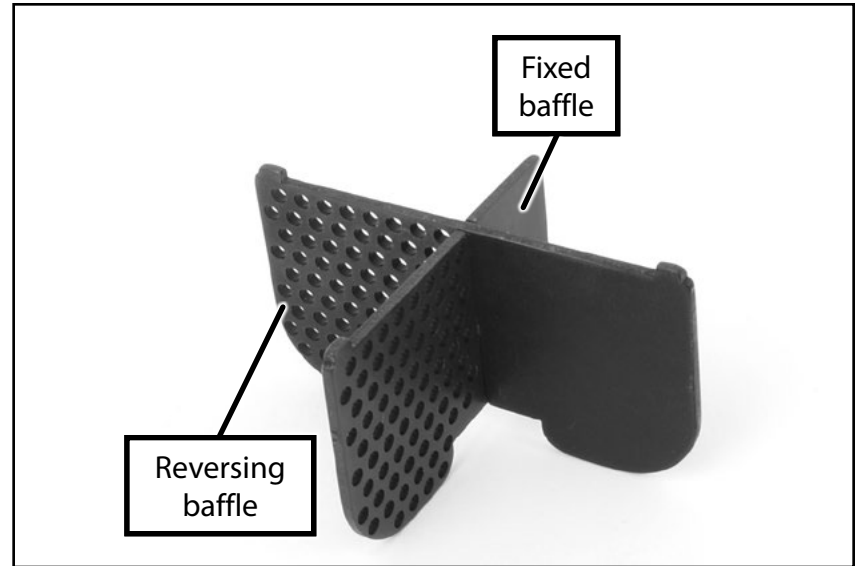

Step 8:

Slide the two baffles apart.

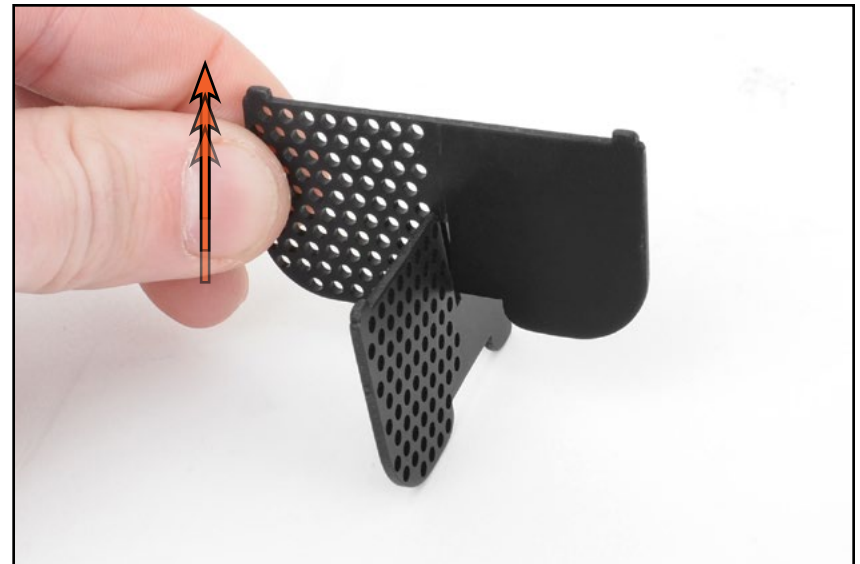

CLEANING AND MAINTENANCE

Step 9:

Clean the separator baffles, housing, and reservoir, using any mild cleanser or solvent. Note in the picture on the right that the fixed baffle is shorter than the reversing baffle.



Any mild cleanser or solvent can be used to clean the catch can, however we recommend that you test all cleansers on an inconspicuous area inside the reservoir to check for discoloration before you clean the outside surfaces.

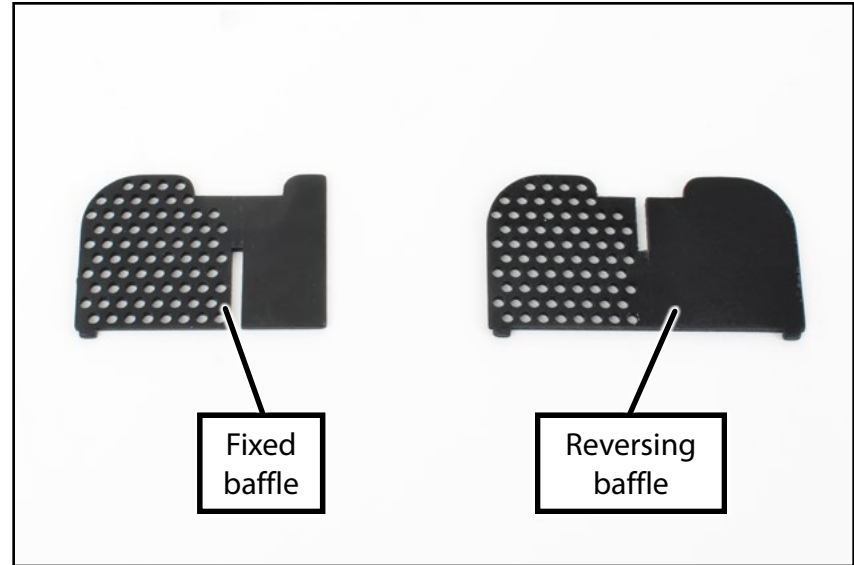

Step 10:

Reassemble the baffles into the separator housing and make sure that the baffles have not been reversed and the feed and return sides are positioned correctly. Reference step 4 in this section to make sure it is properly installed.

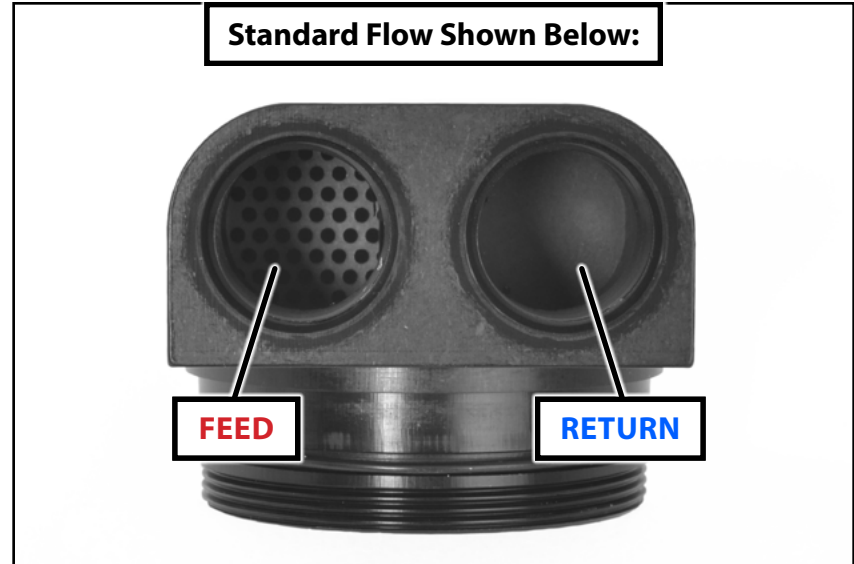

CLEANING AND MAINTENANCE - COLD WEATHER

COLD TEMPERATURE WARNING



In cold temperatures, the crank vent system will generate a much greater amount of moisture which can present a risk of freezing.

When the temperature outside approaches freezing, your catch can should be cleaned on a weekly basis to prevent freeze up of the crank vent system and damage to engine seals.

When the temperature drops below freezing, we recommend reinstalling your original crank vent system components to prevent freeze up of the crank vent system and damage to engine seals.

NEW PRODUCT DETAILS

- ECS Tuning has designed a new Cold Weather Bypass Hose for those who plan to drive during the winter months. This hose installs quickly and easily, eliminating the need to completely remove the system when temperatures drop. This hose can be found on our website at [ES#3183805](#).



REVERSING THE FLOW OF THE CATCH CAN

Step 1:

You can reverse the flow of your catch can in order to create the best mounting location and hose routing for your application. To begin, look into the separator and identify where the feed and return sides are oriented from when the catch can was originally assembled. The feed side of the separator has a number of small holes in it, the return side looks like a flat plate.

Step 2:

Using the 2.5mm allen wrench included with the separator, remove the two baffle plate screws (arrows).

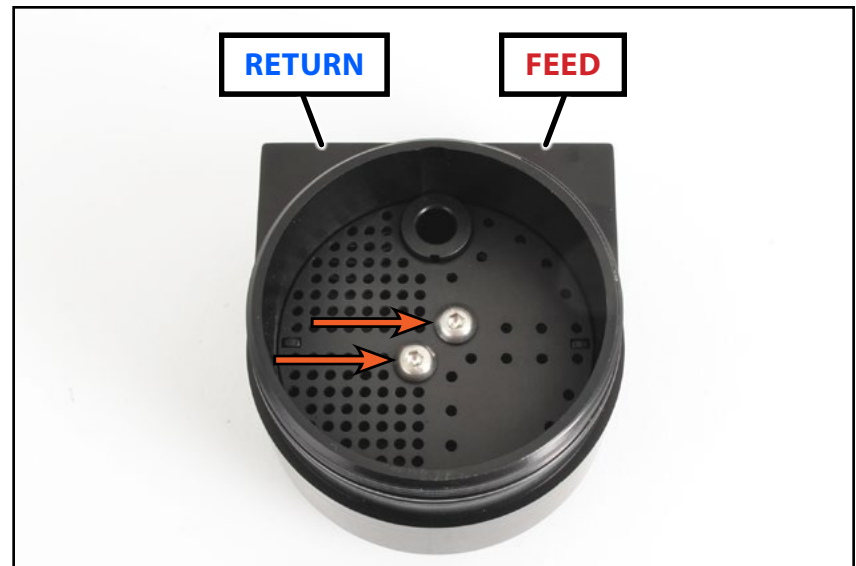
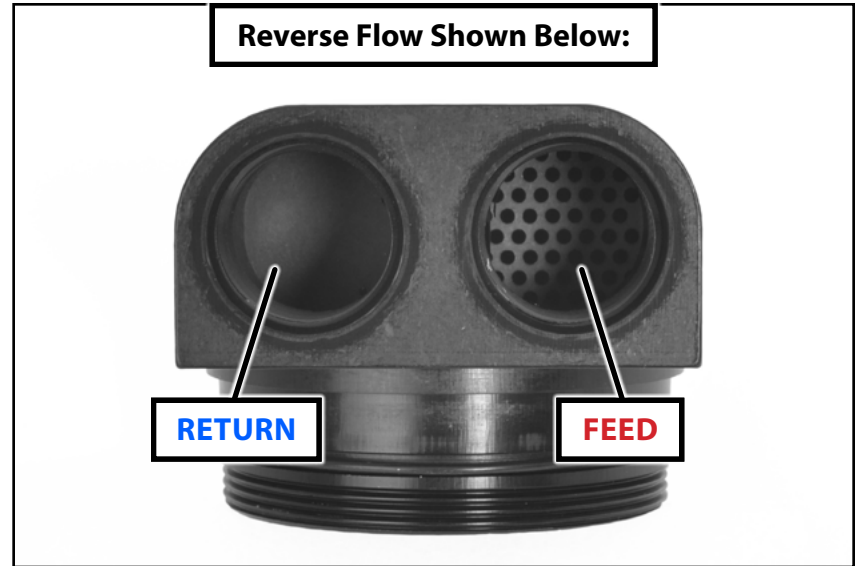

REVERSING THE FLOW OF THE CATCH CAN

Step 3:

Lift the baffle plate out of the separator housing.



Step 4:

Lift the remaining baffles out of the separator housing. Note the position of the inlet screen on the reversing baffle (arrow).



REVERSING THE FLOW OF THE CATCH CAN

Step 5:

Note the positions of the fixed baffle and the reversing baffle.

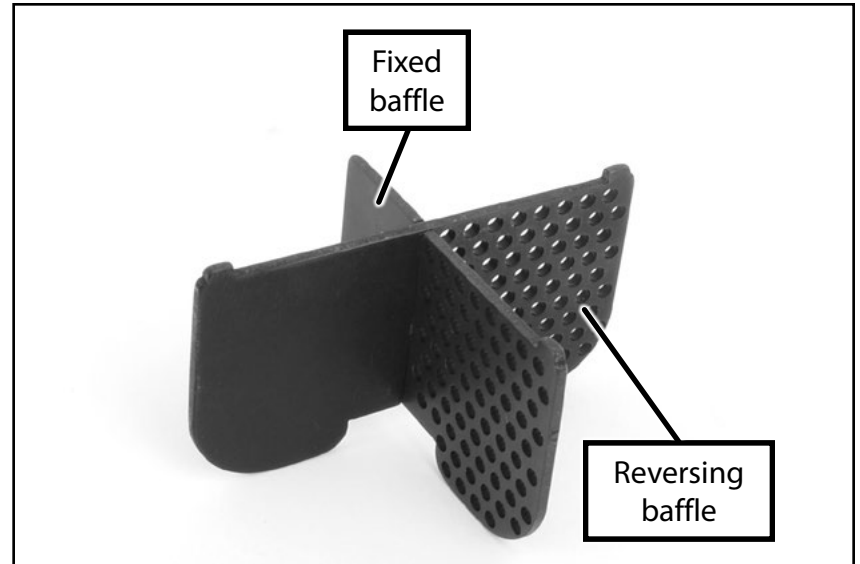

Step 6:

Slide the two baffles apart.

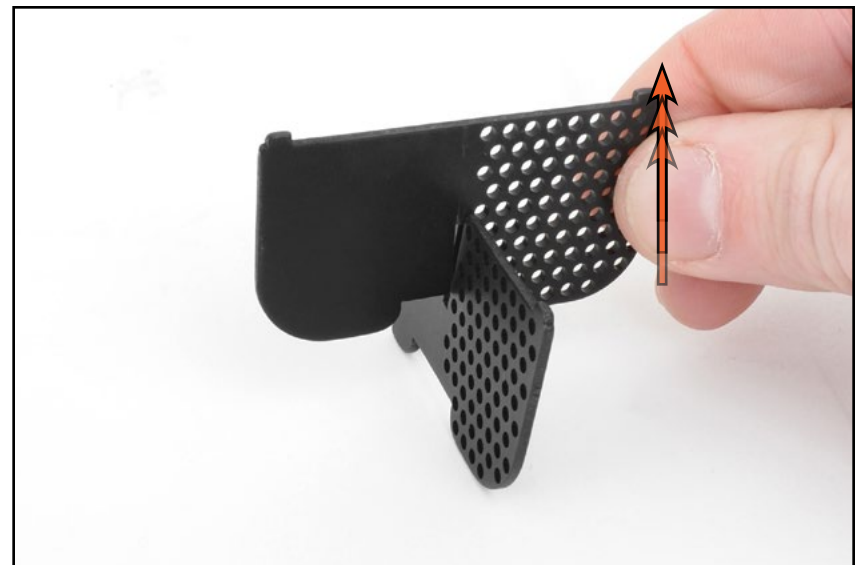

REVERSING THE FLOW OF THE CATCH CAN

Step 7:

Flip the reversing baffle and slide it back onto the fixed baffle.

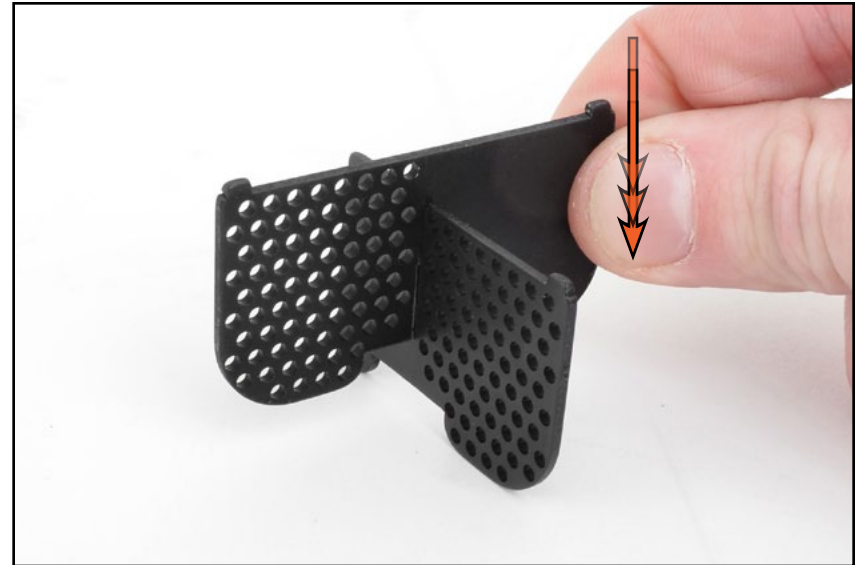

Step 8:

Inspect the inside of the separator housing. You will see that there are two sets of threaded holes for the baffle plate screws. When you reverse the flow, you will use the opposite holes when reinstalling the baffle plate screws.

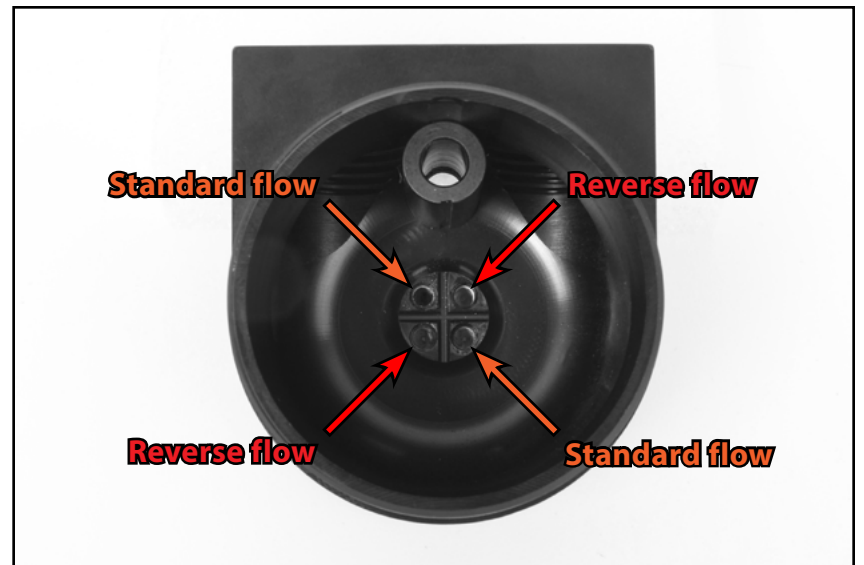

REVERSING THE FLOW OF THE CATCH CAN

Step 9:

Reinstall the baffles into the separator housing. Note that the inlet screen on the reversing baffle should now be located on the opposite side.



Step 10:

Flip the baffle plate so it is opposite of the removal position and place it back into the separator housing.



REVERSING THE FLOW OF THE CATCH CAN

Step 11:

Reinstall the baffle plate screws utilizing the opposite holes in the separator housing. Compare the new baffle plate position with step 2 in this section to make sure it is properly installed for standard flow.

Step 12:

Your standard flow separator will now have the feed side and return side located as shown in the photo.



If you need to return to the installation steps please click [HERE](#).

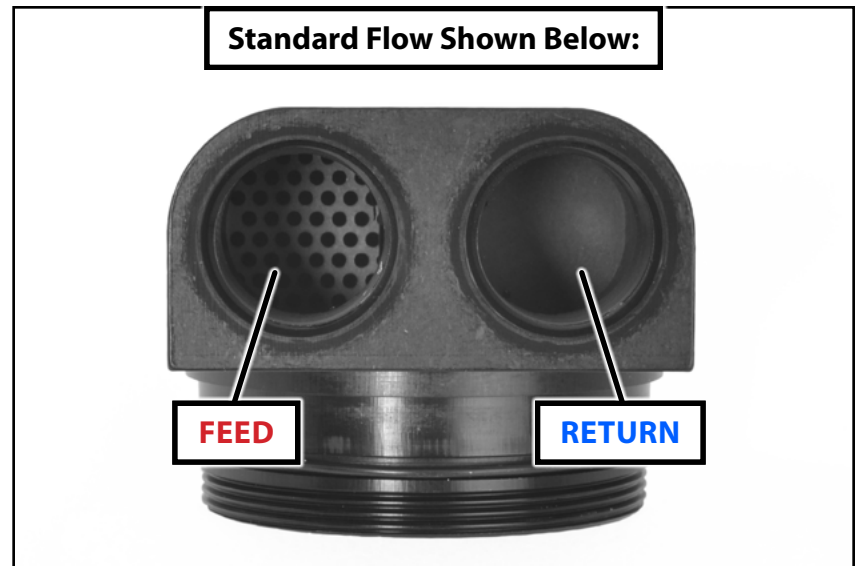
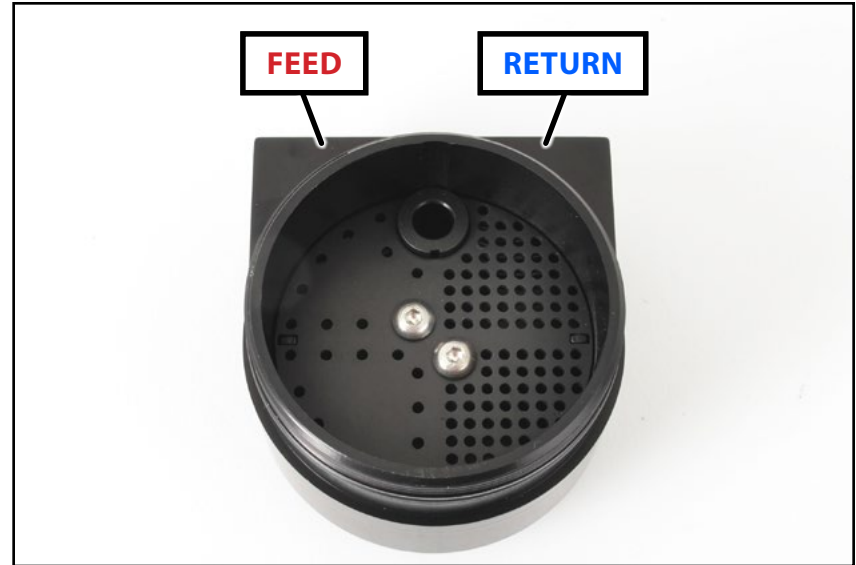

Your Catch Can System installation is complete!



These instructions are provided as a courtesy by ECS Tuning

Proper service and repair procedures are vital to the safe, reliable operation of all motor vehicles as well as the personal safety of those performing the repairs. Standard safety procedures and precautions (including use of safety goggles and proper tools and equipment) should be followed at all times to eliminate the possibility of personal injury or improper service which could damage the vehicle or compromise its safety.

Although this material has been prepared with the intent to provide reliable information, no warranty (express or implied) is made as to its accuracy or completeness. Neither is any liability assumed for loss or damage resulting from reliance on this material. SPECIFICALLY, NO WARRANTY OF MERCHANTABILITY, FITNESS FOR A PARTICULAR PURPOSE OR ANY OTHER WARRANTY IS MADE OR TO BE IMPLIED WITH RESPECT TO THIS MATERIAL. In no event will ECS Tuning, Incorporated or its affiliates be liable for any damages, direct or indirect, consequential or compensatory, arising out of the use of this material.