

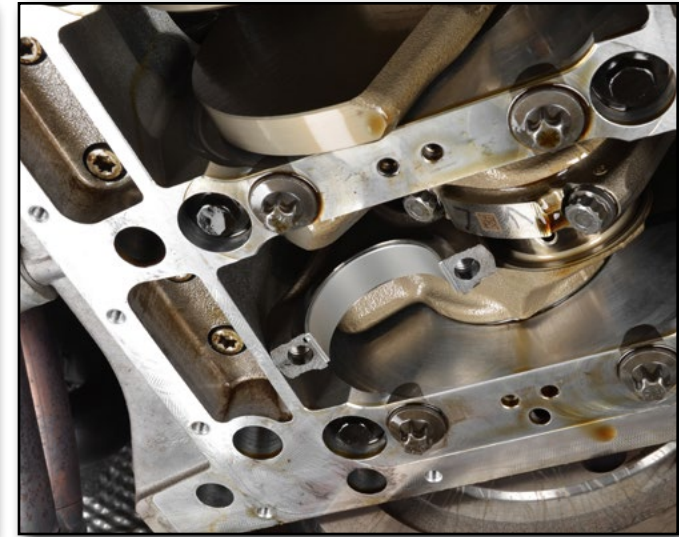

## BMW S65 WPC Treated Rod Bearing Kit Installation Guide



Proper service and repair procedures are vital to the safe, reliable operation of all motor vehicles as well as the personal safety of those performing the repairs. Standard safety procedures and precautions (including use of safety goggles and proper tools and equipment) should be followed at all times to eliminate the possibility of personal injury or improper service which could damage the vehicle or compromise its safety.

## INTRODUCTION

# BMW S65 Connecting Rod Bearing Replacement

The S65 engine is a masterpiece of engineering and technology, known for a linear power band and insanely high revs, this motor can really sing! Unfortunately it is also known to suffer from premature rod bearing wear which, if left untreated, can lead to engine failure. There are several factors which contribute to this issue including the bearing material composition, and lack of routine maintenance.

Our kit includes all of the gaskets and seals you'll need, as well as WPC treated genuine BMW upper and lower bearing shells. What is WPC, you ask? WPC is a surface treatment that reduces friction and adds strength, two improvements which greatly benefit internal engine components. Ultra-fine particles are fired at the bearing surface at very high speeds, like shot-peening, but **much** smaller. The parts come out smoother and stronger due to thermal discharge. The two largest enemies of any high-performance engine are heat and friction, and the WPC treatment will help to reduce both of them.

The photo on the right shows the bearings we removed from our E90 M3. Note the wear patterns on the upper shells, we didn't experience any sort of failure but we were very happy that we decided to replace our rod bearings when we did! The wear patterns you can see on our old bearings are pretty typical for vehicles between 40-60k miles on original, untreated rod bearings.

Replacing the rod bearings in your S65 can be a tough job, even if you have some "wrench time" under your belt, but we're here to help! We've taken the guesswork out of this job and put together the perfect kit for you, and we'll walk you through the entire procedure step by step.

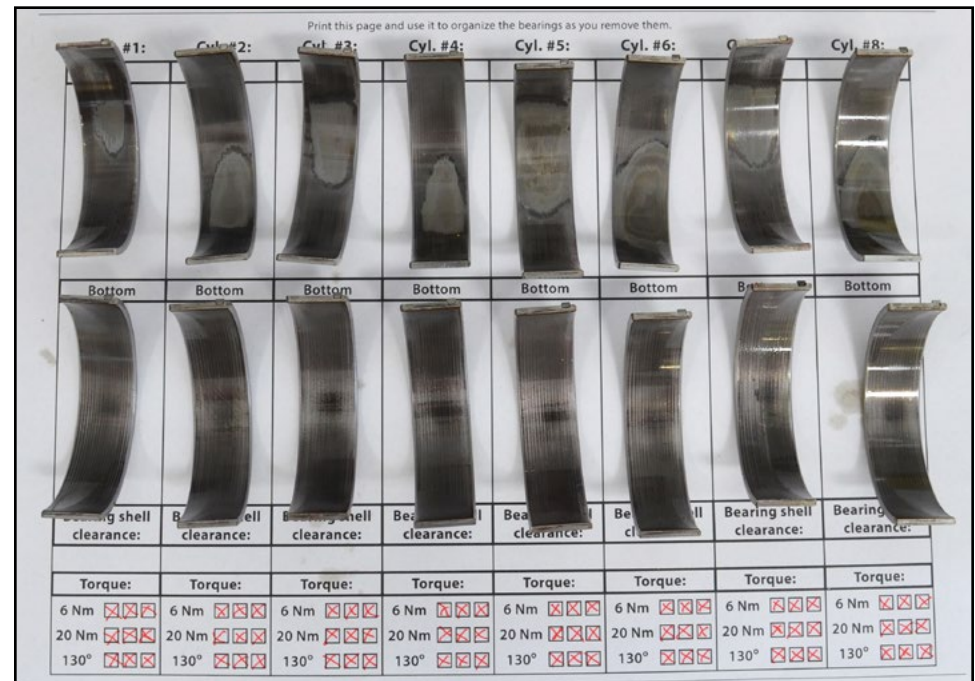

## TABLE OF CONTENTS

Kit Contents.....	<a href="#">pg.4</a>
Installation and Safety Information.....	<a href="#">pg.5</a>
Project Overview.....	<a href="#">pg.6</a>
BMW S65 Connecting Rod Bearing Organizer.....	<a href="#">pg.7</a>
Disassembly Procedure.....	<a href="#">pg.8</a>
Installing the New Connecting Rod Bearings.....	<a href="#">pg.25</a>
Reassembly Procedure.....	<a href="#">pg.30</a>

## KIT CONTENTS

**NOTE:**

- Upper shells are marked w/**BLUE** paint
- Lower shells are marked w/**RED** paint

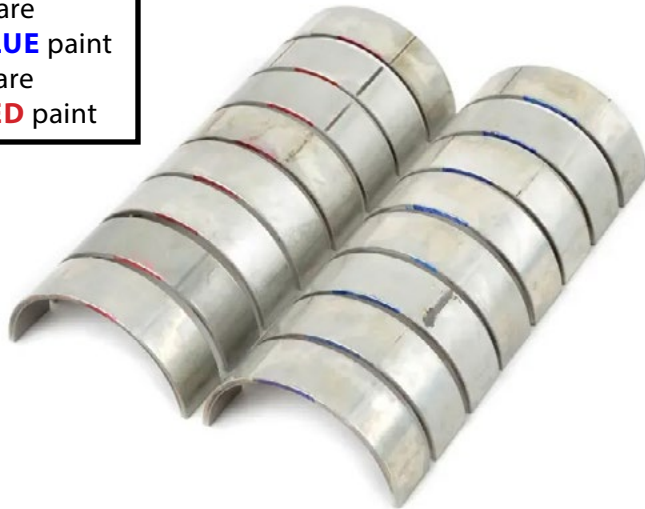

WPC Treated Rod Bearing Shells (QTY 16)

**Option #1: OEM Rod Bolts**  
(CANNOT be reused, three step torque procedure)



**Option #2: ARP Rod Bolts**  
(CAN be reused, single step torque procedure)

Rod Bolts (QTY 16)



Oil Service Kit\* (QTY 1)

\*Includes two extra liters of oil not shown in the photo

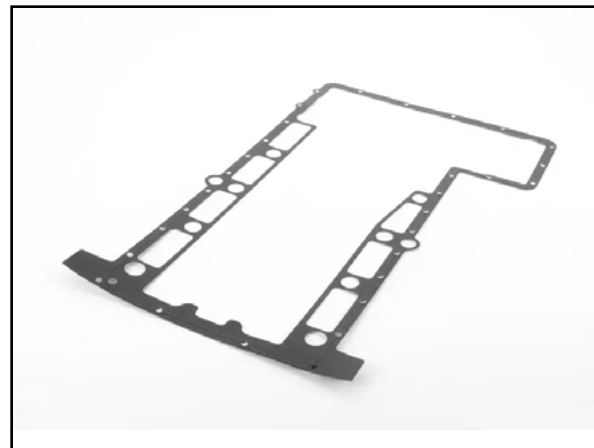

Oil Sump Gasket (QTY 1)



Assembly Lube (QTY 1)

## INSTALLATION NOTES

- **RH** refers to the *passenger side* of the vehicle.
- **LH** refers to the *driver side* of the vehicle.
- Always use the proper torque specifications.
- If applicable to this installation, torque specifications will be listed throughout the document and at the end as well.
- Please read all of these instructions and familiarize yourself with the complete process **BEFORE** you begin.

## GENERAL PREPARATION AND SAFETY INFORMATION

Turner Motorsport cares about your health and safety, please read the following safety information. This information pertains to automotive service in general, and while it may not pertain to every job you do, please remember and share these important safety tips.

- Park your car in a safe, well lit, level area.
- Shut the engine off and remove the key from the ignition switch.
- Make sure any remote start devices are properly disabled.
- **ALWAYS** wear safety glasses.
- Make sure the parking brake is applied until the vehicle is safely lifted and supported.
- Whether lifting a vehicle using an automotive lift or a hydraulic jack, be sure and utilize the factory specified lift points.
- Lifting a vehicle in an incorrect location can cause damage to the suspension/running gear.
- **ALWAYS** support the vehicle with jack stands.
- **ALWAYS** read and follow all safety information and warnings for the equipment you are using.



**NEVER** get underneath a vehicle that is supported only by a jack, and **ALWAYS** make sure that the vehicle is securely supported on jack stands.

## PROJECT OVERVIEW

For your convenience we've included a bearing organizer sheet on the next page for you to print off. This will help you to keep track of your bearing shells, observe wear patterns, and you can use the check boxes along the bottom to record your progress as you torque the rod bolts.

We've also included the engine cylinder number illustration below for quick reference.

**Now let's get to it!**

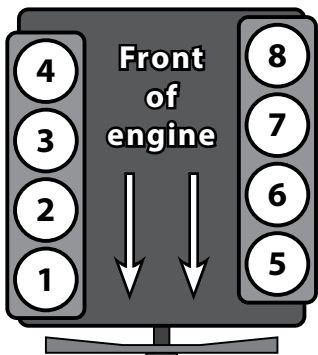

BMW S65 CONNECTING ROD BEARING ORGANIZER

Print this page and use it to organize the bearings as you remove them. **Note:** If you're using ARP rod bolts they must be torqued to 50 Ft-lbs.

Cyl. #1:	Cyl. #2:	Cyl. #3:	Cyl. #4:	Cyl. #5:	Cyl. #6:	Cyl. #7:	Cyl. #8:
Top	Top	Top	Top	Top	Top	Top	Top
Bottom	Bottom	Bottom	Bottom	Bottom	Bottom	Bottom	Bottom
Bearing shell clearance:	Bearing shell clearance:	Bearing shell clearance:	Bearing shell clearance:	Bearing shell clearance:	Bearing shell clearance:	Bearing shell clearance:	Bearing shell clearance:
Torque:	Torque:	Torque:	Torque:	Torque:	Torque:	Torque:	Torque:
6 Nm <input type="checkbox"/> <input type="checkbox"/> <input type="checkbox"/>	6 Nm <input type="checkbox"/> <input type="checkbox"/> <input type="checkbox"/>	6 Nm <input type="checkbox"/> <input type="checkbox"/> <input type="checkbox"/>	6 Nm <input type="checkbox"/> <input type="checkbox"/> <input type="checkbox"/>	6 Nm <input type="checkbox"/> <input type="checkbox"/> <input type="checkbox"/>	6 Nm <input type="checkbox"/> <input type="checkbox"/> <input type="checkbox"/>	6 Nm <input type="checkbox"/> <input type="checkbox"/> <input type="checkbox"/>	6 Nm <input type="checkbox"/> <input type="checkbox"/> <input type="checkbox"/>
20 Nm <input type="checkbox"/> <input type="checkbox"/> <input type="checkbox"/>	20 Nm <input type="checkbox"/> <input type="checkbox"/> <input type="checkbox"/>	20 Nm <input type="checkbox"/> <input type="checkbox"/> <input type="checkbox"/>	20 Nm <input type="checkbox"/> <input type="checkbox"/> <input type="checkbox"/>	20 Nm <input type="checkbox"/> <input type="checkbox"/> <input type="checkbox"/>	20 Nm <input type="checkbox"/> <input type="checkbox"/> <input type="checkbox"/>	20 Nm <input type="checkbox"/> <input type="checkbox"/> <input type="checkbox"/>	20 Nm <input type="checkbox"/> <input type="checkbox"/> <input type="checkbox"/>
130° <input type="checkbox"/> <input type="checkbox"/> <input type="checkbox"/>	130° <input type="checkbox"/> <input type="checkbox"/> <input type="checkbox"/>	130° <input type="checkbox"/> <input type="checkbox"/> <input type="checkbox"/>	130° <input type="checkbox"/> <input type="checkbox"/> <input type="checkbox"/>	130° <input type="checkbox"/> <input type="checkbox"/> <input type="checkbox"/>	130° <input type="checkbox"/> <input type="checkbox"/> <input type="checkbox"/>	130° <input type="checkbox"/> <input type="checkbox"/> <input type="checkbox"/>	130° <input type="checkbox"/> <input type="checkbox"/> <input type="checkbox"/>

**If you're using OE rod bearing bolts:**  
Check off each row of boxes as you complete the 3-step rod bearing bolt torque procedure.

**If you're using ARP rod bearing bolts:**  
Check off a single row of boxes as you torque the bolts to 20 Ft-lbs, then 50 Ft-lbs.

Place your bearing shells **HERE**

Write down your measurements **HERE**

Check off these boxes as you torque the rod bearing cap bolts



Print this page and use it to organize the bearings as you remove them. **Note:** If you're using ARP rod bolts they must be torqued to 50 Ft-lbs.

**Cyl. #1:**      **Cyl. #2:**      **Cyl. #3:**      **Cyl. #4:**      **Cyl. #5:**      **Cyl. #6:**      **Cyl. #7:**      **Cyl. #8:**

Top	Top	Top	Top	Top	Top	Top	Top
Bottom	Bottom	Bottom	Bottom	Bottom	Bottom	Bottom	Bottom
Bearing shell clearance:	Bearing shell clearance:	Bearing shell clearance:	Bearing shell clearance:	Bearing shell clearance:	Bearing shell clearance:	Bearing shell clearance:	Bearing shell clearance:
Torque:	Torque:	Torque:	Torque:	Torque:	Torque:	Torque:	Torque:
6 Nm <input type="checkbox"/> <input type="checkbox"/> <input type="checkbox"/>	6 Nm <input type="checkbox"/> <input type="checkbox"/> <input type="checkbox"/>	6 Nm <input type="checkbox"/> <input type="checkbox"/> <input type="checkbox"/>	6 Nm <input type="checkbox"/> <input type="checkbox"/> <input type="checkbox"/>	6 Nm <input type="checkbox"/> <input type="checkbox"/> <input type="checkbox"/>	6 Nm <input type="checkbox"/> <input type="checkbox"/> <input type="checkbox"/>	6 Nm <input type="checkbox"/> <input type="checkbox"/> <input type="checkbox"/>	6 Nm <input type="checkbox"/> <input type="checkbox"/> <input type="checkbox"/>
20 Nm <input type="checkbox"/> <input type="checkbox"/> <input type="checkbox"/>	20 Nm <input type="checkbox"/> <input type="checkbox"/> <input type="checkbox"/>	20 Nm <input type="checkbox"/> <input type="checkbox"/> <input type="checkbox"/>	20 Nm <input type="checkbox"/> <input type="checkbox"/> <input type="checkbox"/>	20 Nm <input type="checkbox"/> <input type="checkbox"/> <input type="checkbox"/>	20 Nm <input type="checkbox"/> <input type="checkbox"/> <input type="checkbox"/>	20 Nm <input type="checkbox"/> <input type="checkbox"/> <input type="checkbox"/>	20 Nm <input type="checkbox"/> <input type="checkbox"/> <input type="checkbox"/>
130° <input type="checkbox"/> <input type="checkbox"/> <input type="checkbox"/>	130° <input type="checkbox"/> <input type="checkbox"/> <input type="checkbox"/>	130° <input type="checkbox"/> <input type="checkbox"/> <input type="checkbox"/>	130° <input type="checkbox"/> <input type="checkbox"/> <input type="checkbox"/>	130° <input type="checkbox"/> <input type="checkbox"/> <input type="checkbox"/>	130° <input type="checkbox"/> <input type="checkbox"/> <input type="checkbox"/>	130° <input type="checkbox"/> <input type="checkbox"/> <input type="checkbox"/>	130° <input type="checkbox"/> <input type="checkbox"/> <input type="checkbox"/>

## DISASSEMBLY PROCEDURE

Step 1: 10mm Socket & Ratchet

Disconnect the negative (-) battery cable (arrow).



Step 2: Flat Blade Screwdriver

Remove the air boxes and inlet tubes (highlighted in **GREEN**).





## DISASSEMBLY PROCEDURE

### Step 3:

Now it's time to remove the coil pack covers. The LH cover is easy to remove, simply pull the hose out of the retaining clips, lift upward on the coil pack cover to release it from its mounting grommets, and remove it from the engine (highlighted in **GREEN** in **photo #1**).



The RH coil cover is a little trickier to remove. Space is tight on that side of the engine, and the coolant expansion tank will need to be moved aside to get the coil cover out. Remove the two 10mm bolts (arrows in **photo #2**) from the expansion tank, then pull the RH coil cover (highlighted in **GREEN** in **photo #3**) out between the expansion tank and the engine.

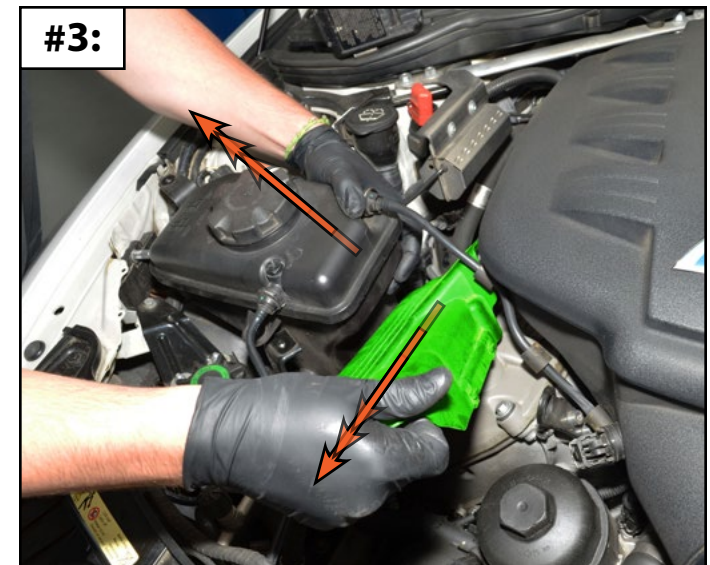
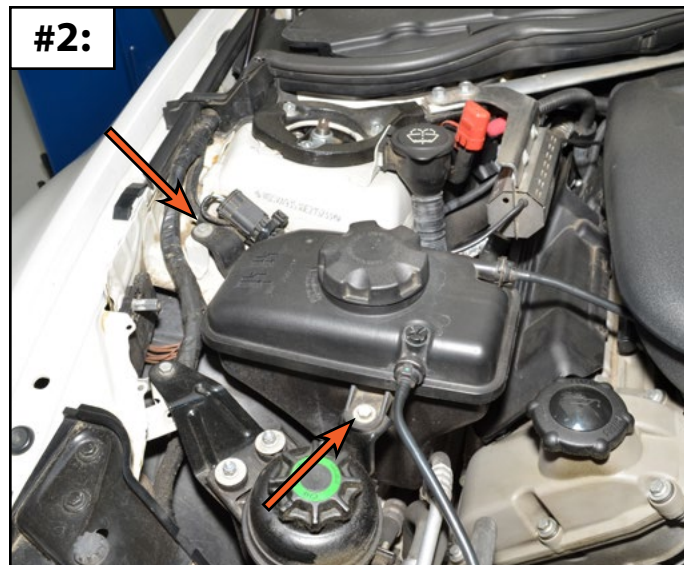

## DISASSEMBLY PROCEDURE

### Step 4:

Release the electrical connectors from all eight coil packs (**photo #1**).

Remove all eight coil packs from the engine (**photo #2**). This step can be performed with a coil pack puller, or if you are extremely careful you can use a flat blade screwdriver to pry the coil outward.

Remove all eight spark plugs from the engine (**photo #3**).

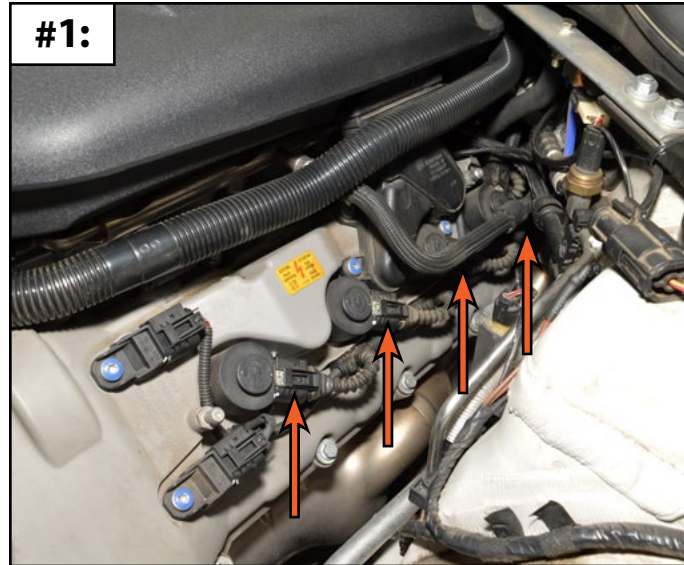

## DISASSEMBLY PROCEDURE

### Step 5: 6mm Hex (Allen)

Safely lift and support the vehicle, then remove the front wheels. If you haven't done so yet, now is a good time to start draining the oil from the engine.



### Step 6:

Remove the belly pans (highlighted in **GREEN** and **BLUE**).





# Please read this entire page before proceeding



We know that we need to remove the subframe (or at least lower it) in order to access and replace the rod bearings, this part is unavoidable. In these instructions we chose to completely remove our subframe and the power steering rack for better access. This also made it much easier to get our cameras in for more detailed photos. Here's a quick breakdown of the different paths you can choose from:

1. Remove the subframe, but leave the steering rack hanging in the vehicle.
  - This procedure is outlined in the ECS N54 turbo replacement video (click [HERE](#) or on **photo #1**).
  - **You WILL need to disconnect/remove:**
    - The outer tie rod ends, control arms, front sway bar & end links, steering shaft (**photo #3**).
  - **You WON'T need to disconnect/remove:**
    - The power steering lines (**photo #2**).
2. Unbolt the subframe and lower it just enough to gain access to the oil sump.
  - This leaves **VERY** little room to work, and makes it very difficult to accurately torque the bolts without expansive specialty tools.
  - **You WILL need to disconnect/remove:**
    - The steering shaft (**photo #3**).
    - You'll need to lower the sump until it rests on the subframe, then remove the front oil pickup tube before sliding sump out (not shown).
  - **You WON'T need to disconnect/remove:**
    - The outer tie rod ends, control arms, front sway bar & end links, steering shaft, or power steering lines (**photo #2**).
3. Remove the subframe and steering rack all as one.
  - Requires a little more effort, but it will give the most room to work.
  - You'll need to top up and bleed the power steering system after reassembling the vehicle.
  - **You WILL need to disconnect/remove:**
    - The outer tie rod ends, control arms, front sway bar & end links, steering shaft, and power steering lines (**photo #2**).

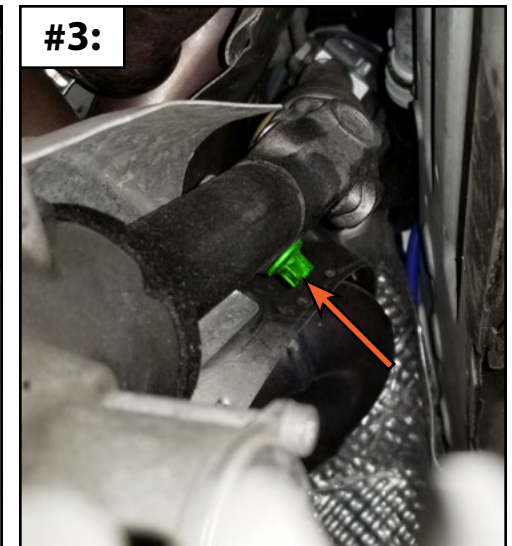
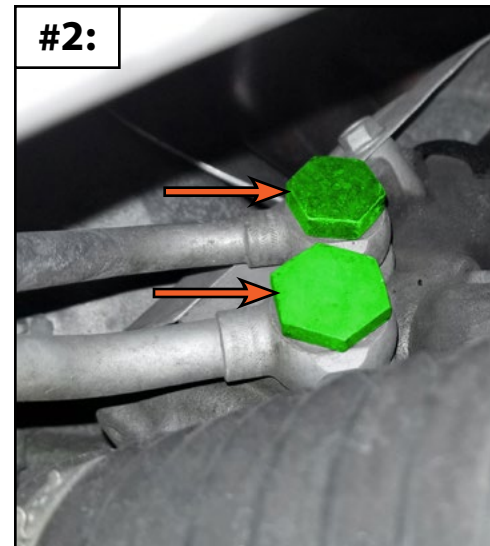

## DISASSEMBLY PROCEDURE

### Step 7:

We need to release the hose set bracket (highlighted in **RED** in **photo #1**) from the front of the subframe, this can be done without disconnecting any of the hoses. Remove the two 10mm bolts which secure the bracket to the front of the subframe (**photo #2**).

Remove the 10mm nut which secures the hard line to the subframe, this is located next to the LH sway bar bracket (**photo #3**).

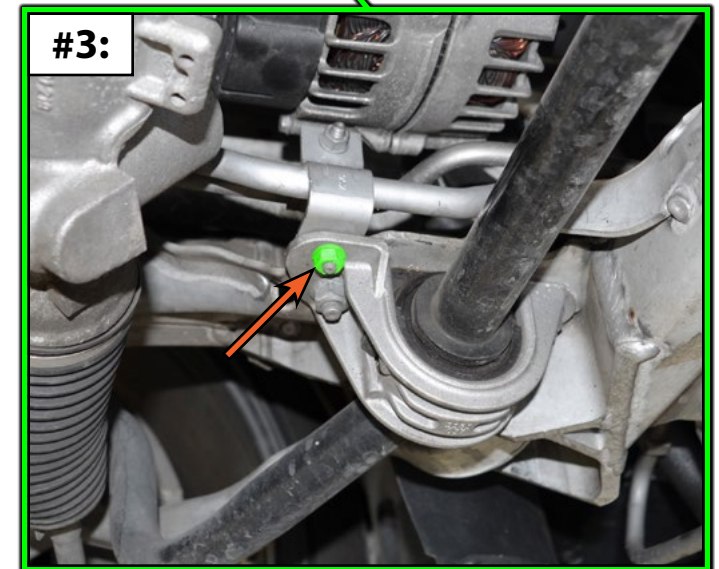
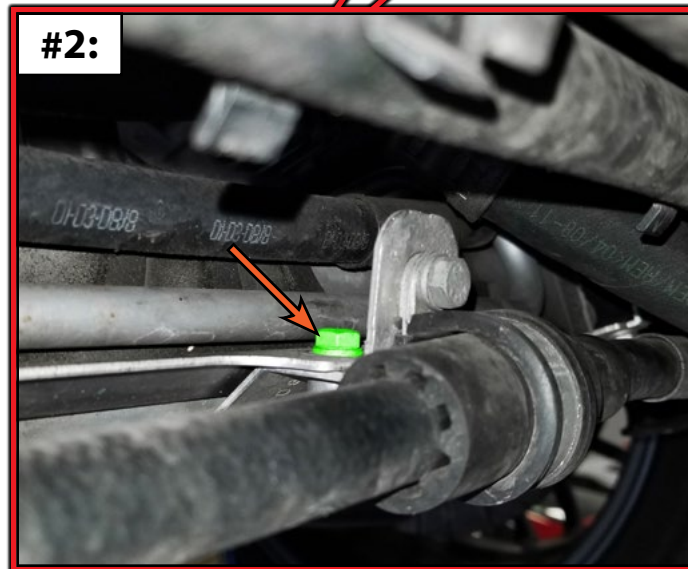
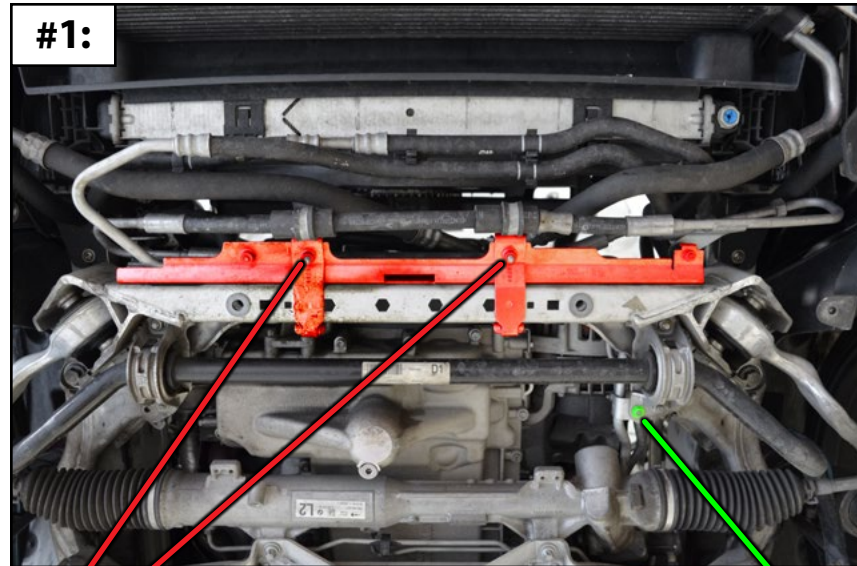

## DISASSEMBLY PROCEDURE

**Step 8:** 21mm Socket & Impact, 18mm Socket & Ratchet

Remove the outer tie rod end from the spindles (nut highlighted in **GREEN** in **photo #1**).

Remove the thrust arms from the subframe (bolt highlighted in **GREEN** in **photo #2**).



Skip steps 8 & 9 if you are not removing the subframe.

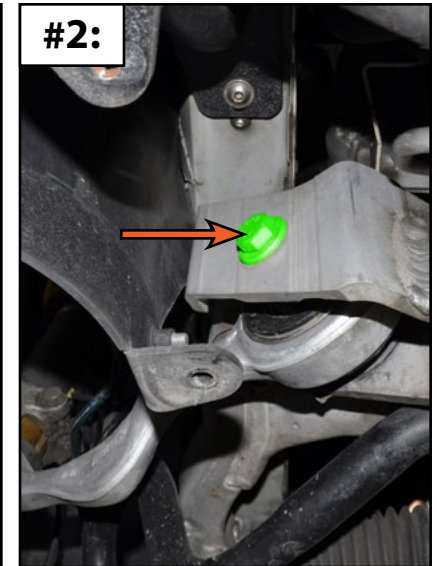
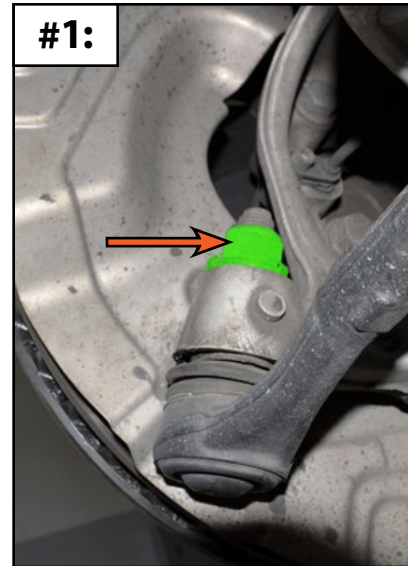

**Step 9:** 10mm Socket, 18mm Wrench, 18mm Socket & Ratchet

Remove the nut which secures the headlight leveling sensor to the LH lower control arm, remove the nuts which secure the sway bar end links to the sway bar, then remove the lower control arm bolts from the subframe (all fasteners are highlighted in **GREEN** in the photo).

There is no need to disconnect the wiring harness from the headlight leveling sensor, when the LH control arm bolt is removed you will be able to swing the leveling sensor out of the way.

Swing the control arms and thrust arms out of the way, but leave them connected to the spindles (not shown).

Don't forget to disconnect the active steering electrical connector from the steering rack (shown in the inset photo).

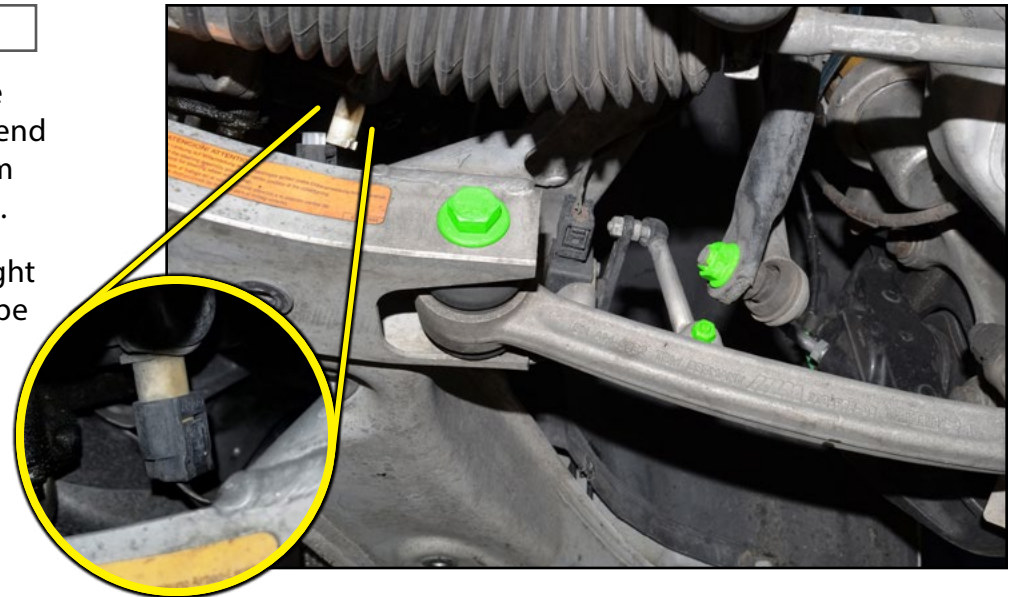

## DISASSEMBLY PROCEDURE

### Step 10: 16mm Socket & Ratchet

Remove the two nuts (circled in **YELLOW** in the photo) which secure the engine mounts to the subframe.

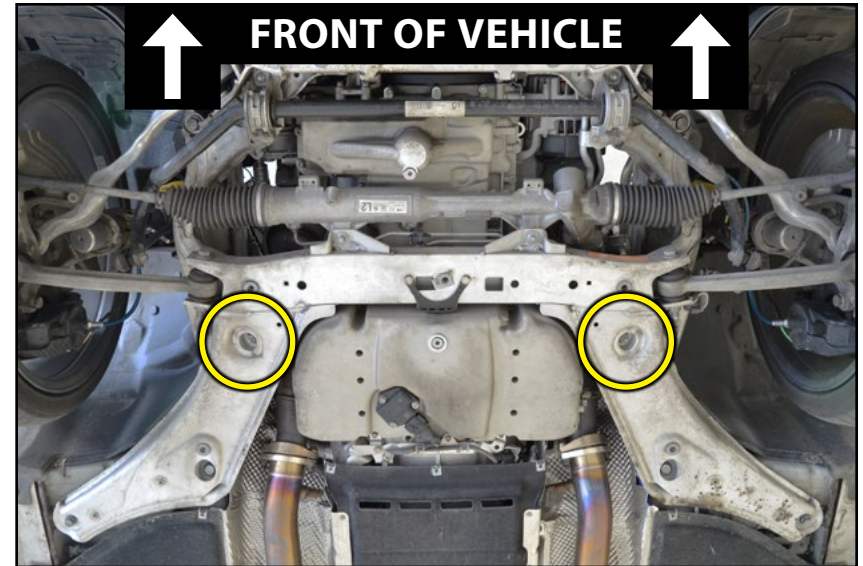

### Step 11: Schwaben Engine Support Bar

Support the engine from above. There is a factory lifting point on the RH front corner of the engine, we found that were able to support the weight from this single point on our M3.

Lift the engine approximately one inch, the goal here is to take the weight of the engine off of the subframe (not shown). You can leave the engine mounts connected to the engine.



## DISASSEMBLY PROCEDURE

### Step 12:



Before you lower or remove the subframe make sure that the steering shaft u-joint has been disconnected from the steering rack (E11 Torx bolt highlighted in **GREEN** in **photo #1**).



If you are planning on removing the steering rack you'll also need to disconnect the power steering lines at this time (highlighted in **GREEN** in **photo #2**).

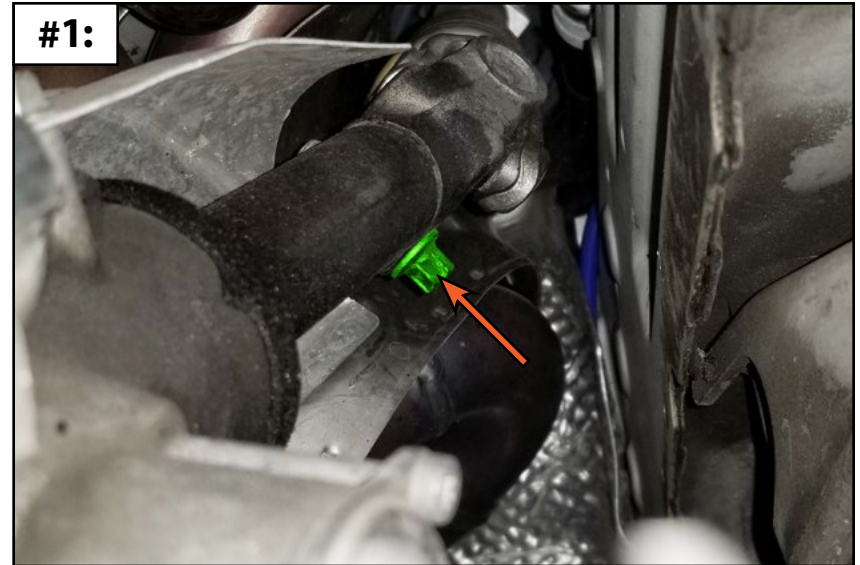



## DISASSEMBLY PROCEDURE

Step 13: 18mm Socket & Breaker Bar - or - Impact

Support the subframe from below (shown in **photo #1**). Locate and remove the eight bolts which secure the subframe to the chassis (circled in **YELLOW** in **photo #2**).

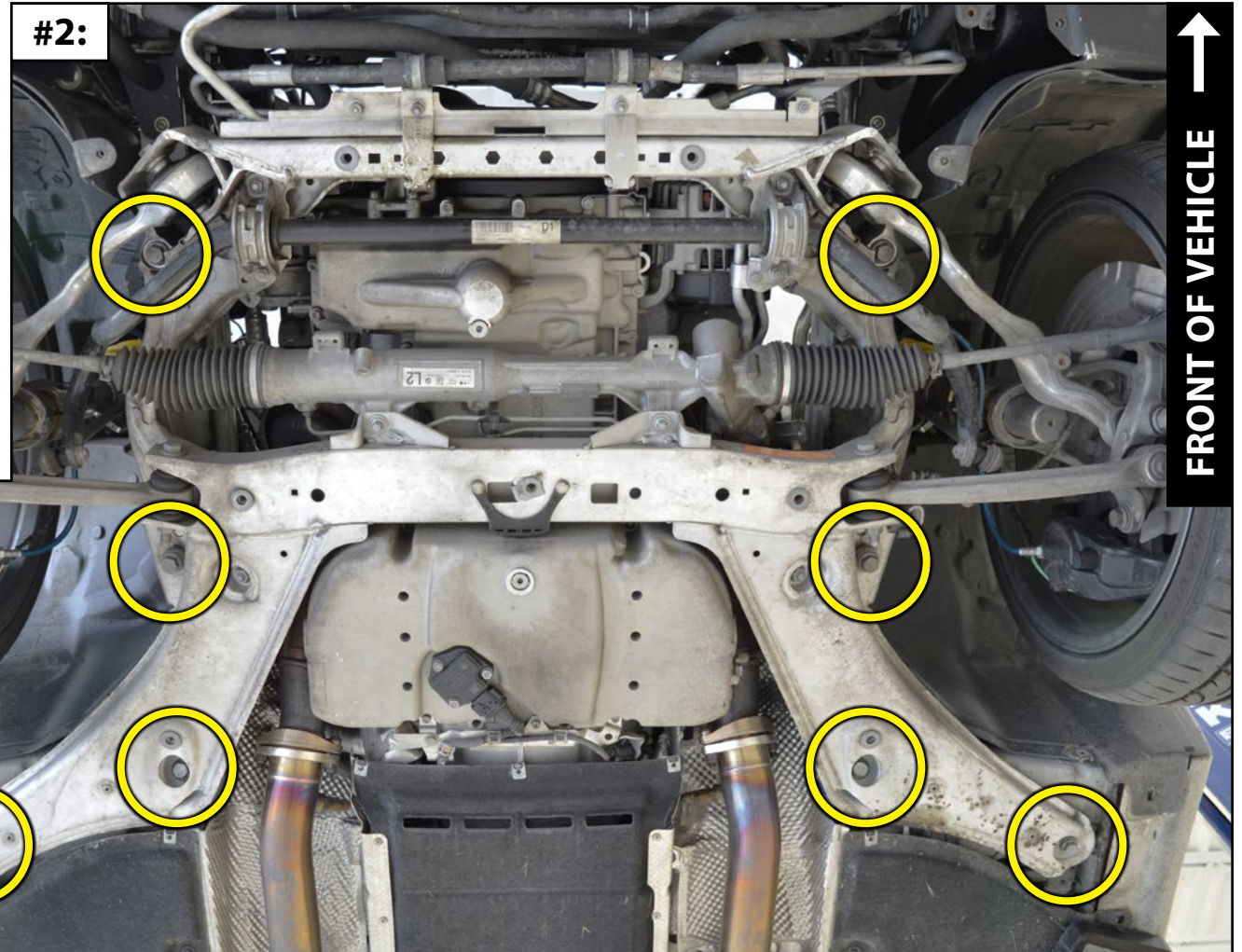
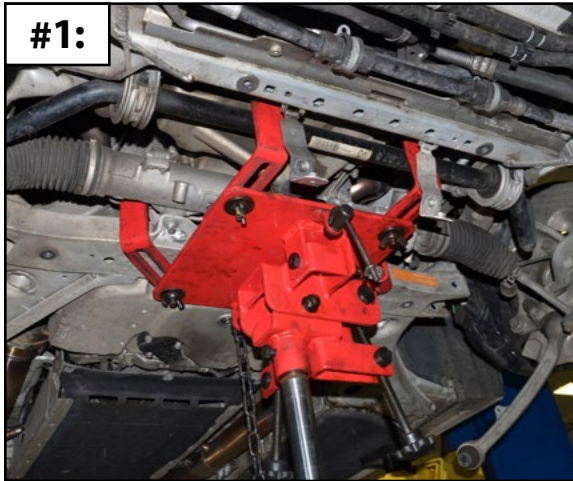

## DISASSEMBLY PROCEDURE

### Step 14:

Carefully lower the subframe (highlighted in **GREEN**) and set it aside. You may need to pull the subframe rearward slightly while lowering it in order to clear various components.



## DISASSEMBLY PROCEDURE

**Step 15:** 14mm Wrench, 10mm & 13mm Sockets, Ratchet, T30 Torx

The A/C belt tensioner damper is mounted to the front RH corner of the oil sump, we need to remove it to access several bolts underneath. Start by removing the plastic cover from the A/C belt tensioner pulley (not shown), then use a 14mm wrench to grab the pulley bolt (highlighted in **CYAN**) and rotate the tensioner clockwise so you can pull the belt off of the pulley.

With the belt removed you'll need to unbolt the tensioner damper from the mounting bracket (13mm bolt highlighted in **RED**). Release the hard line from the damper mounting bracket (10mm nut circled and highlighted in **ORANGE**). Remove the damper mounting bracket from the oil sump (T30 bolts highlighted in **GREEN**).

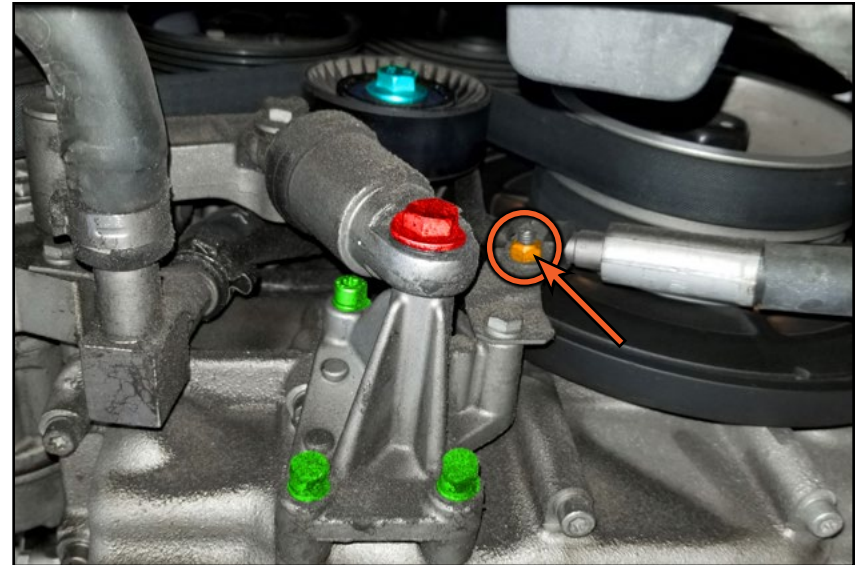

**Step 16:** 8mm & 10mm Sockets, Ratchet

Remove the transmission insulation panel (highlighted in **GREEN**).



## DISASSEMBLY PROCEDURE

### Step 17: 10mm Socket & Ratchet, T30 Torx

Remove the five bolts which secure the O2 sensor wiring harness bracket (highlighted in **GREEN**) to the back of the engine (**ORANGE** arrows in the photo). Disconnect the oil level sensor (**CYAN** arrow in the photo) and the crank position sensor (inset photo).

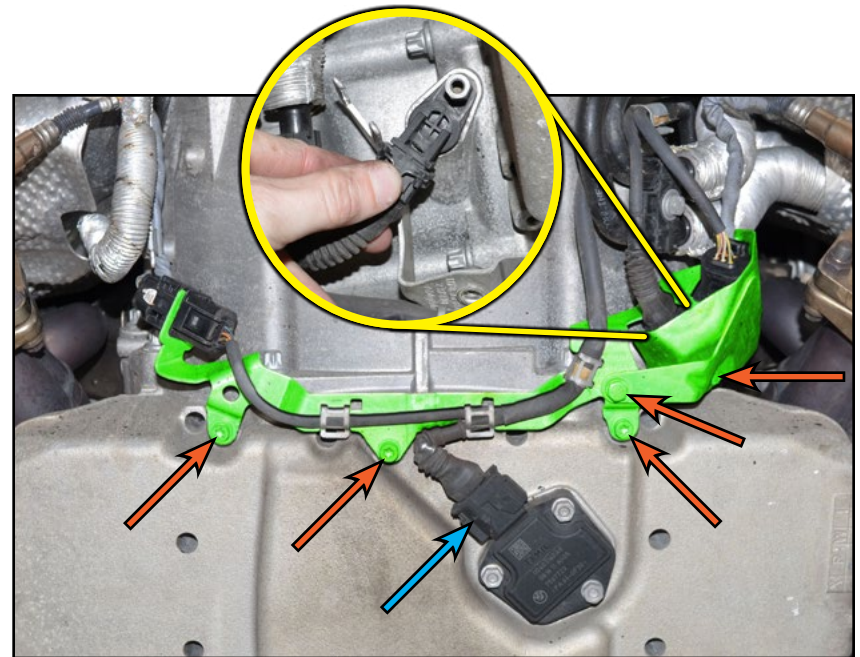

### Step 18: E12 Torx

Remove the four bell housing bolts (highlighted in **CYAN** in **photo #1**). The bell housing bolt on the far RH side gave us some trouble since it was so close to the hard line. We ended up using a 10mm ratcheting wrench to get it loose (**photo #2**).

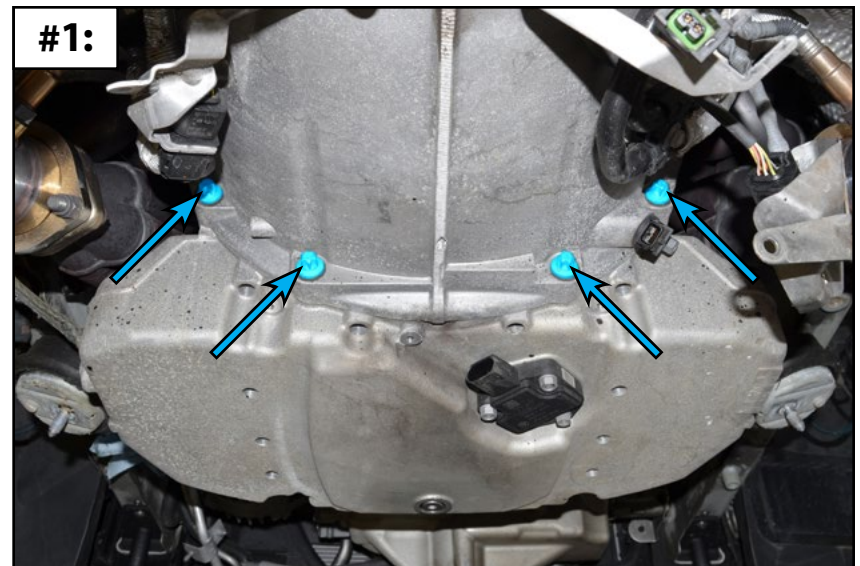

## DISASSEMBLY PROCEDURE

### Step 19: 13mm Socket & Ratchet

Remove the ground cable from the LH rear of the oil sump.

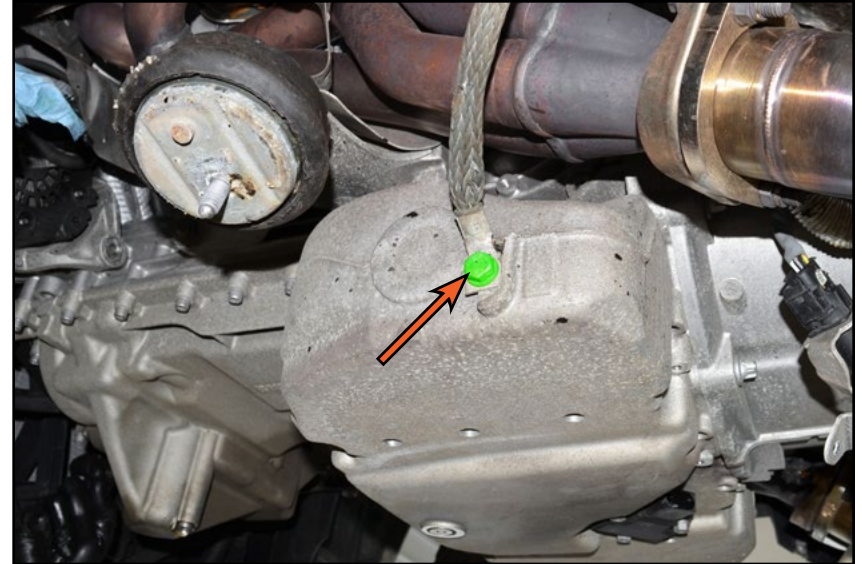

### Step 20: 10mm Socket & Ratchet

Remove the two bolts (highlighted in **GREEN**) which secure the A/C line bracket to the front LH corner of the oil sump.

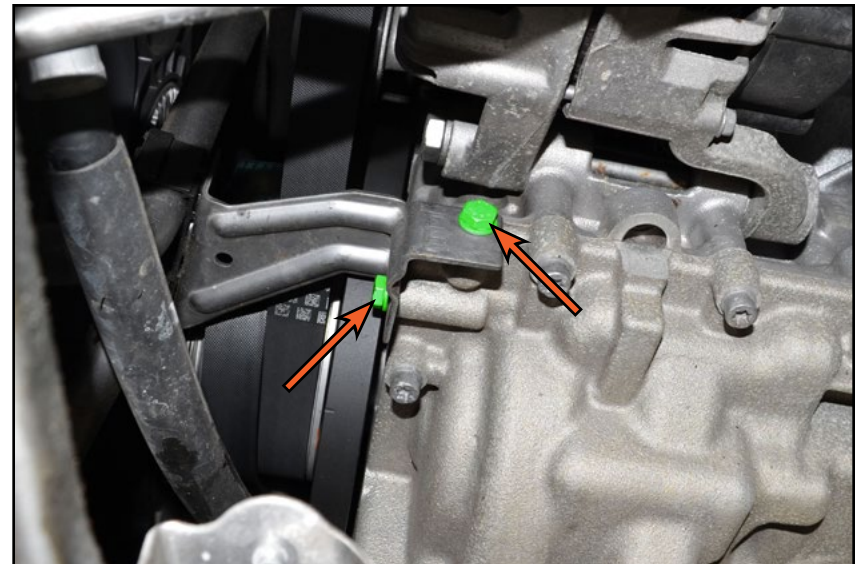

## DISASSEMBLY PROCEDURE

### Step 21: T30 Torx



Even though you drained the oil earlier, there will still be 2-3 quarts left inside the sump. Be aware of this when you are preparing to remove the sump.

There are 30x bolts which secure the oil sump to the engine.

Note the three different bolt lengths which are called out in the photo on the right, we would advise that you refer back to this photo later on when you are reinstalling the lower sump to ensure that all bolts are installed into the correct locations.

Now you'll notice that the bolts which are recessed inside the oil pan are rather difficult to get at with a socket. There are special tools out there which can be used for this, but we ended up taking our 1/4" drive T30 socket to the bench grinder until it fit inside the holes (**photo #2**). This particular socket is included in [T#363536](#).

Carefully lower the oil sump once all of the bolts have been removed.



**M6x75mm bolts (QTY 2)**

**M6x50mm bolts (QTY 12)**

**M6x30mm bolts (QTY 16)**

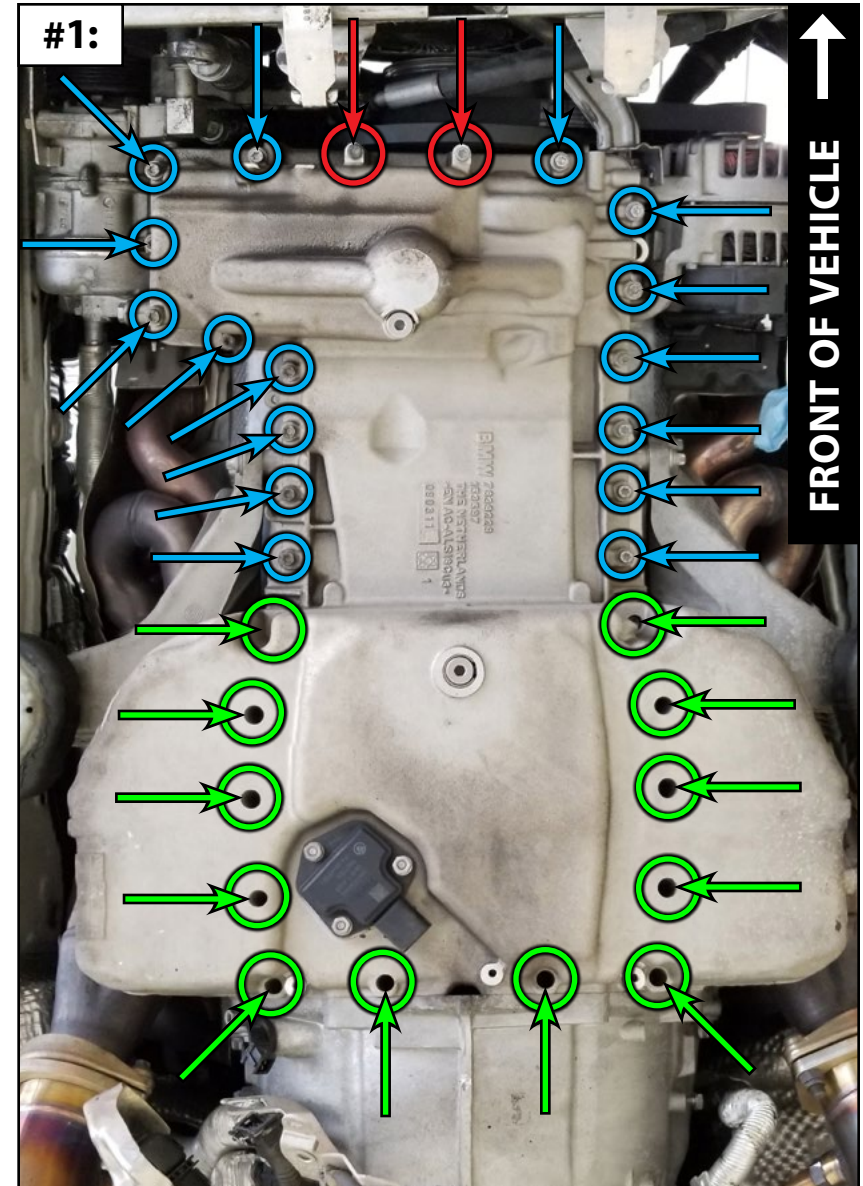

## DISASSEMBLY PROCEDURE

### Step 22:

Now it's time to remove the oil pickups. Remove the two 10mm bolts and three T30 Torx bolts which secure the pickups to the block (highlighted in **GREEN** in **photo #1**).

Once all of the bolts have been removed you can pull the pickups rearward and remove them (**photo #2**).

Remove the four T30 bolts which secure the oil pickup mounting bracket underneath cylinders #4 & #8 (highlighted in **GREEN** in **photo #3**).

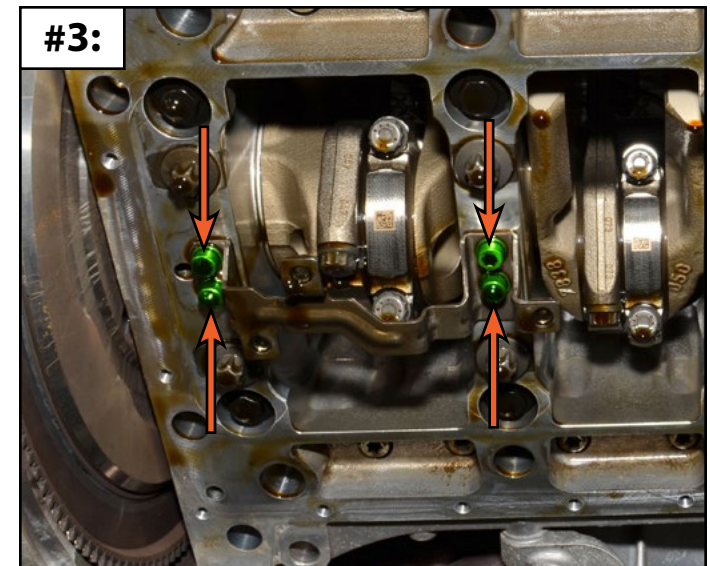
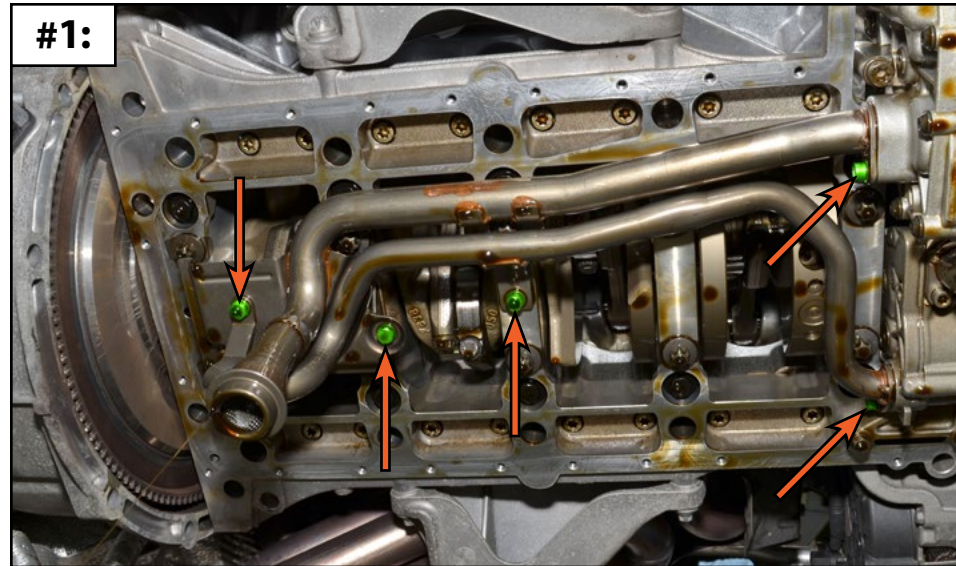

## DISASSEMBLY PROCEDURE

### Step 23:

It's almost time to start replacing the rod bearings. Now is a good time to wipe the rod bearing caps with a clean rag, then mark the cylinder number and direction on the cap with a marker (inset photo).

Starting on the next page we will walk you through how to replace your rod bearings. We strongly recommend that you start by working on whichever rods are located closest to BDC (bottom dead center). Then, once those bearings have been replaced and the bolts have been torqued, rotate the engine clockwise (as viewed from the front of the engine looking at the crank pulley) with a 32mm socket and a breaker bar until the next pair of rods reach BDC, and work on those rod bearings next. Doing so will allow you to replace all of the bearings while only rotating the engine over one full rotation.

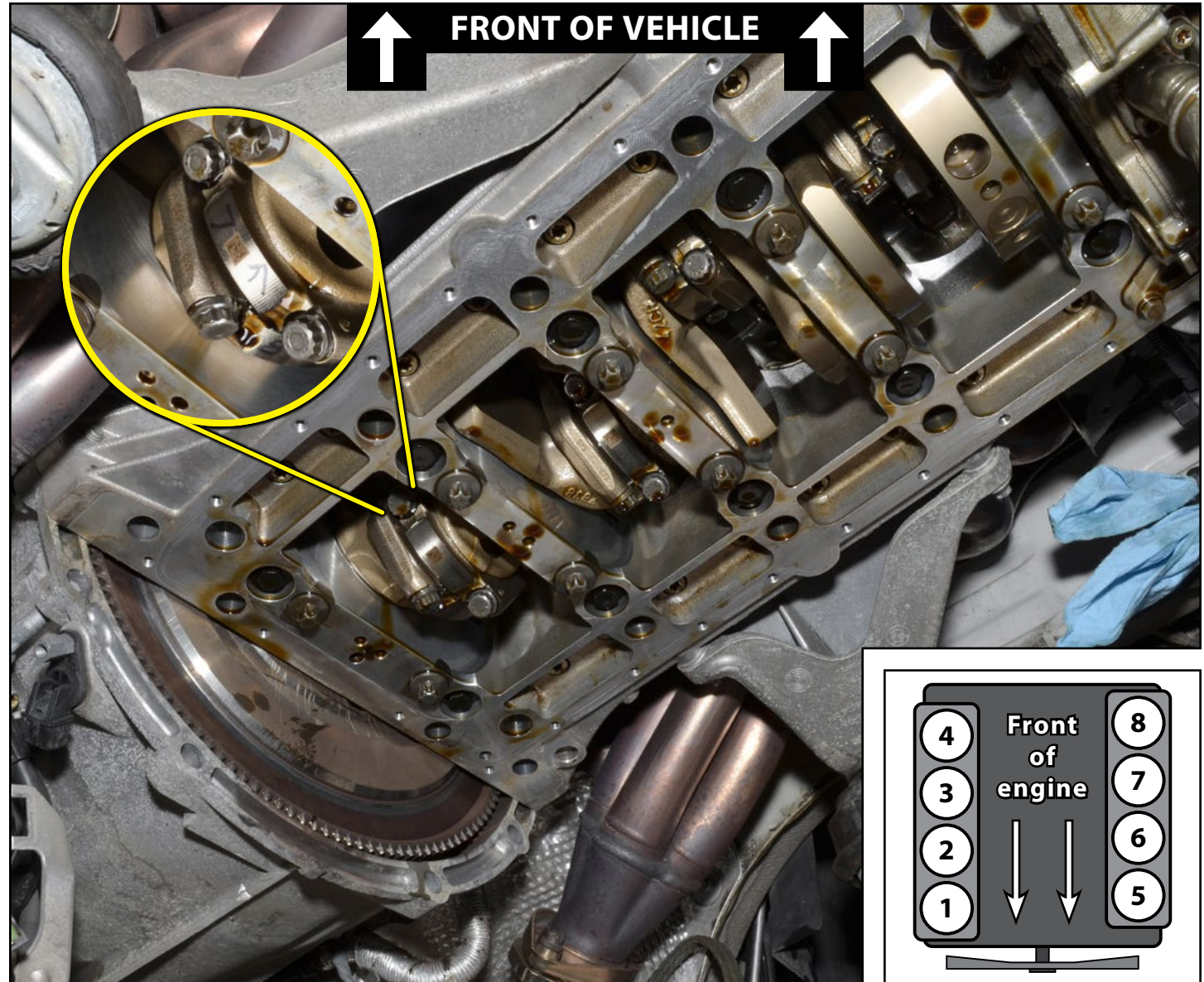



## INSTALLING THE NEW CONNECTING ROD BEARINGS

Step 1:



We strongly recommend that you read this entire section (Pages 27-31) **before** starting to replace any of the bearings. We're going to review replacing the bearing shells, using Plastigage® to check bearing clearance, coating the bearing surfaces with assembly lube, and finally reassembly and torque specifications.



Remove the rod bearing cap from the rod, then remove and inspect the bearing shells. Thoroughly clean the rods and caps before installing the new bearing shells, they should be dry and free of oil before proceeding.

Place the new lower bearing shell (marked w/**RED** paint) into the cap, and place the new upper bearing shell (marked w/**BLUE** paint) into the connecting rod. Be sure to align the locating tang (highlighted in **GREEN** in **photo #1**) with the grooves in the cap and the connecting rod. Push the bearing shells until they are fully seated, and are sitting flush on each side (**photos #2 & #3**).

Repeat this procedure on all of the rod bearings, and use our S65 bearing organizer sheet to keep everything in order.

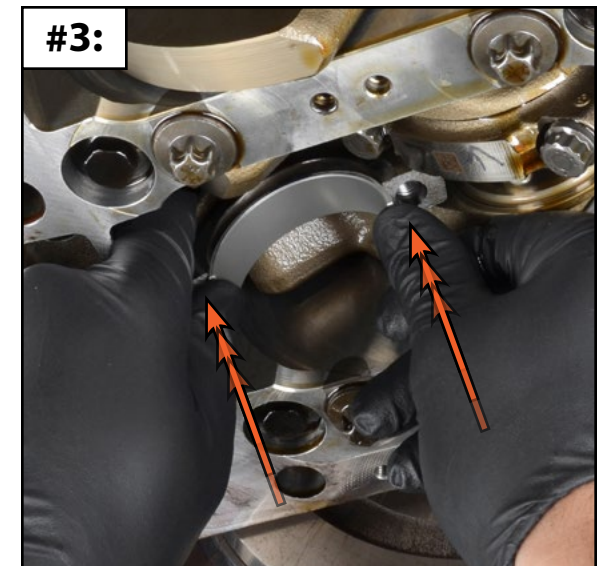
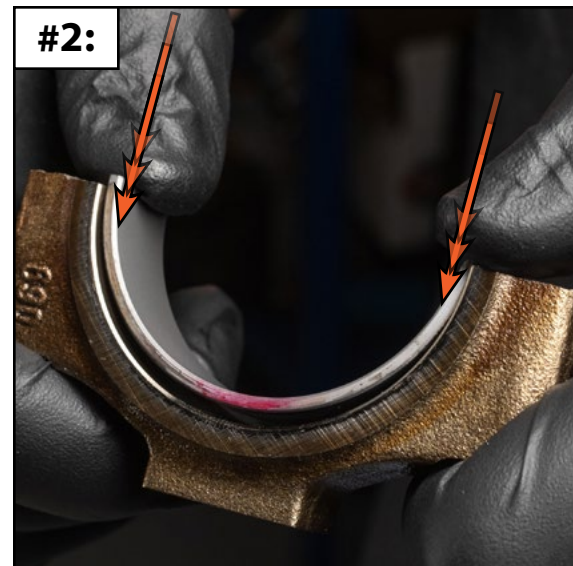

## INSTALLING THE NEW CONNECTING ROD BEARINGS

### Step 2:

Now it's time to check the bearing clearance. The easiest way to do this at home is with Plastigage®.

Cut a short length ( $\frac{1}{4}$ "- $\frac{1}{2}$ " ) of **GREEN** Plastigage® and place it inside the bearing cap (**photo #1**). It's important to note that the bearing shells and crankshaft must be completely dry and free of any oil for accurate Plastigage® readings.

#### If you are using OE rod bolts:

- Use the **OLD** rod bolts to install the connecting rod cap into place (**photo #2**).
- Be careful to install the bearing cap into place without sliding it around on the crank journal, this could smear the Plastigage® and throw off your bearing clearance measurement.

#### If you are using ARP rod bolts:

- Use the **NEW** ARP rod bolts to install the connecting rod cap into place (not shown).
- Be careful to install the bearing cap into place without sliding it around on the crank journal, this could smear the Plastigage® and throw off your bearing clearance measurement.

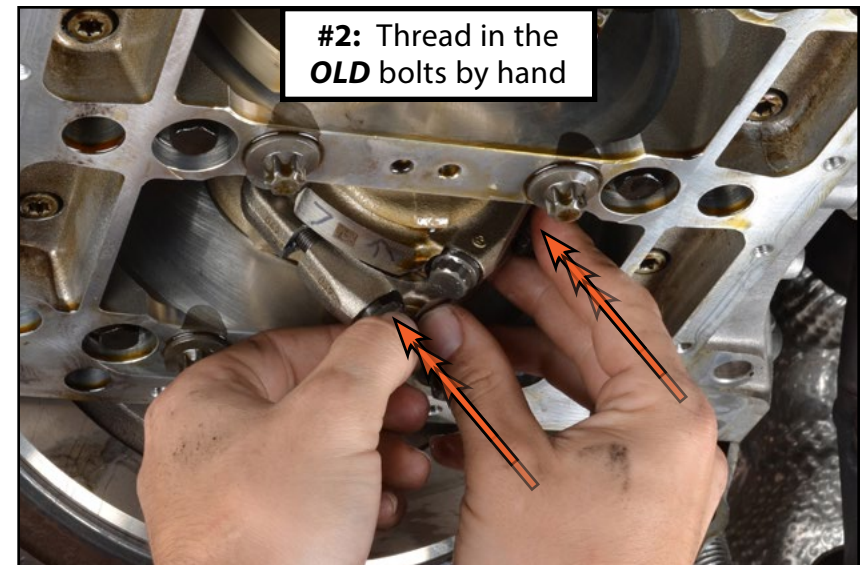
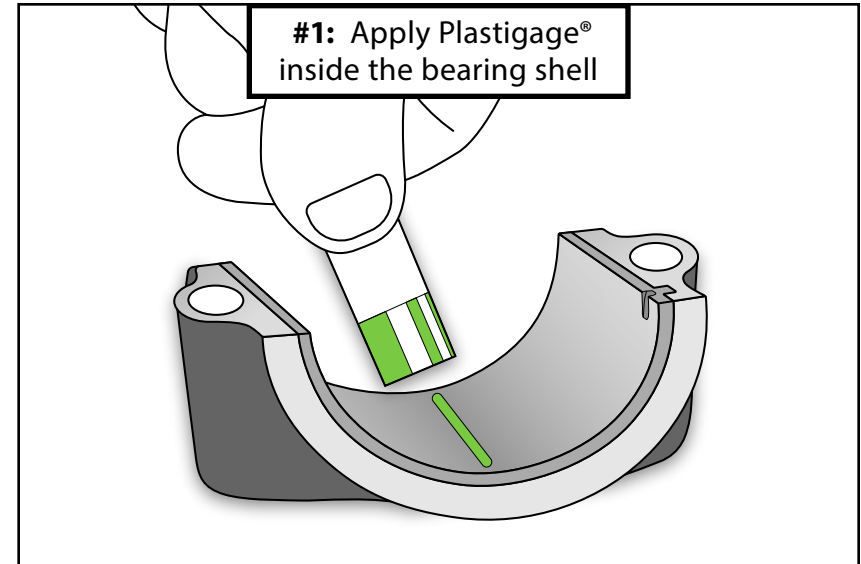

## INSTALLING THE NEW CONNECTING ROD BEARINGS

### Step 3:

Please reference the rod bolt torque specs listed below. Take your time in this step, work on one rod at a time, and use the check boxes on our bearing organizer sheet ([Page 7](#)) to mark down each rod bolt as you torque them to spec.

#### If you are using OE rod bolts:

##### • Stage 1

1. Initial torque 5 Nm
2. Setting torque 20 Nm
3. Additional turn 130°
4. **IMPORTANT** Loosen rod bolts

##### • Stage 2

1. Initial torque 5 Nm
2. Setting torque 20 Nm
3. Additional turn 130°
4. **IMPORTANT** Loosen rod bolts

##### • Stage 3

1. Initial torque 5 Nm
2. Setting torque 20 Nm
3. Additional turn 130°

#### • **Complete all three stages on ALL rod bolts**

#### If you are using ARP rod bolts:

1. Initial torque 20 Ft-lbs
2. Final torque 50 Ft-lbs



## INSTALLING THE NEW CONNECTING ROD BEARINGS

### Step 4:

Remove the bearing cap and inspect the now compressed Plastigage® on the crank journal (**photo #1**). Use the ruler on the Plastigage® packet to measure the width, this will tell you what the bearing clearance is (**photo #2**).

The rod bearing clearance specification for S65 engines with WPC treated rod bearings (*w/part numbers ending in 702 or 703*) is:

- **0.0381 - 0.0546mm**

If your bearing clearance does not fall within that specification, we would strongly recommend that you **STOP** now and take your engine to a machine shop for evaluation.

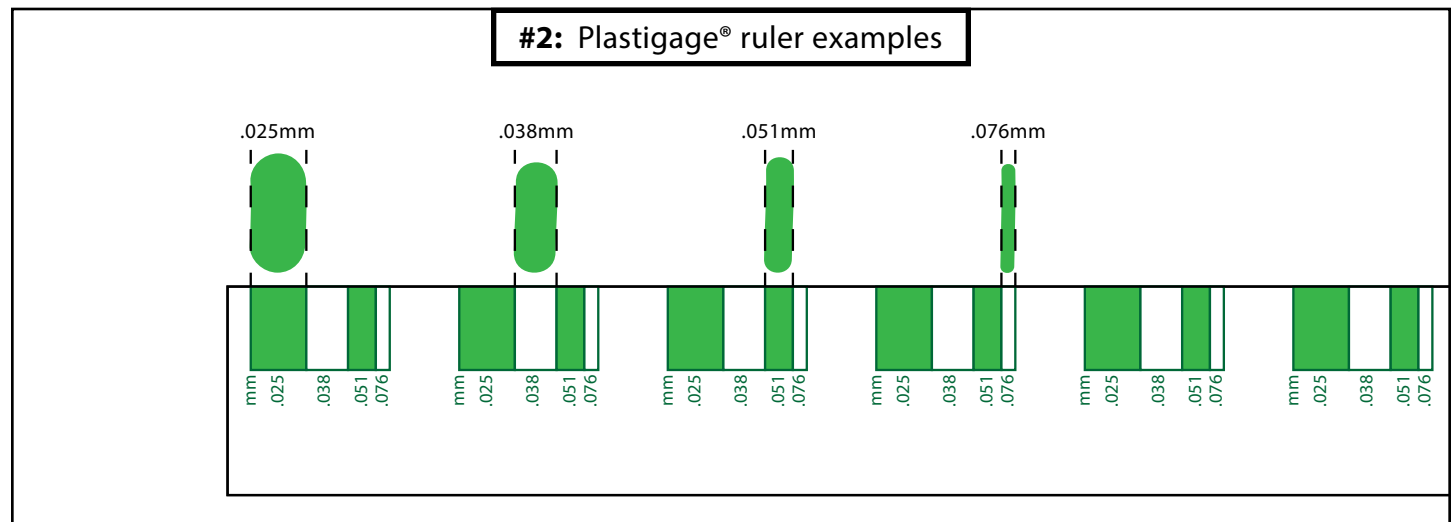

## INSTALLING THE NEW CONNECTING ROD BEARINGS

### Step 5:

All Plastigage® should now be gently removed from the bearing and crank journal. Coat the inside of the bearing shells with assembly lube (we're referring to the surfaces which ride up against the crank journal, not the surfaces which sit inside the connecting rod or the connecting rod cap).

#### If you are using OE rod bolts:

- Discard the old rod bolts.
- Install the bearing caps with the **NEW** bolts (**photo #1**).
- Torque the rod bolts to spec (reference [Page 27](#)).
- Repeat this procedure on all rods bearings (**photo #2**).

#### If you are using ARP rod bolts:

- DO NOT discard the ARP rod bolts, they are reusable.
- Install the bearing caps with the **NEW** ARP rod bolts (not shown).
- Torque the rod bolts to spec (reference [Page 27](#)).

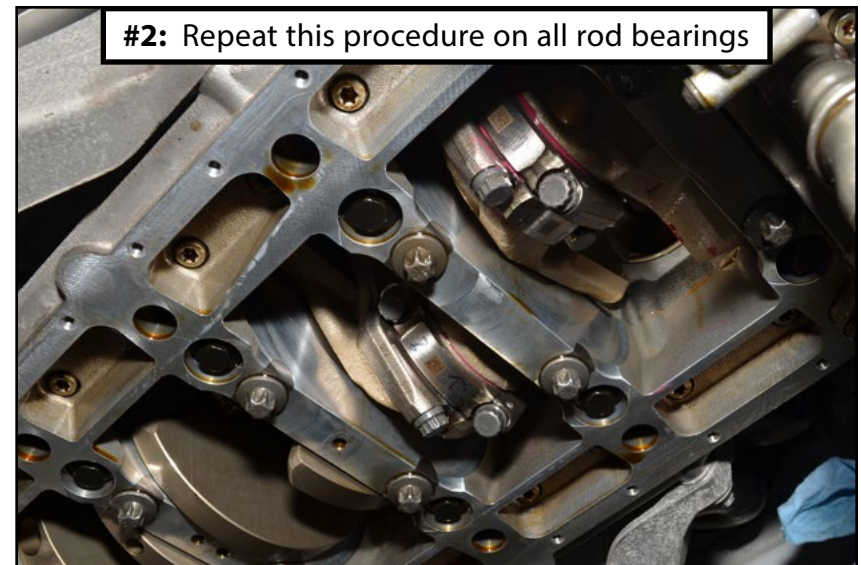
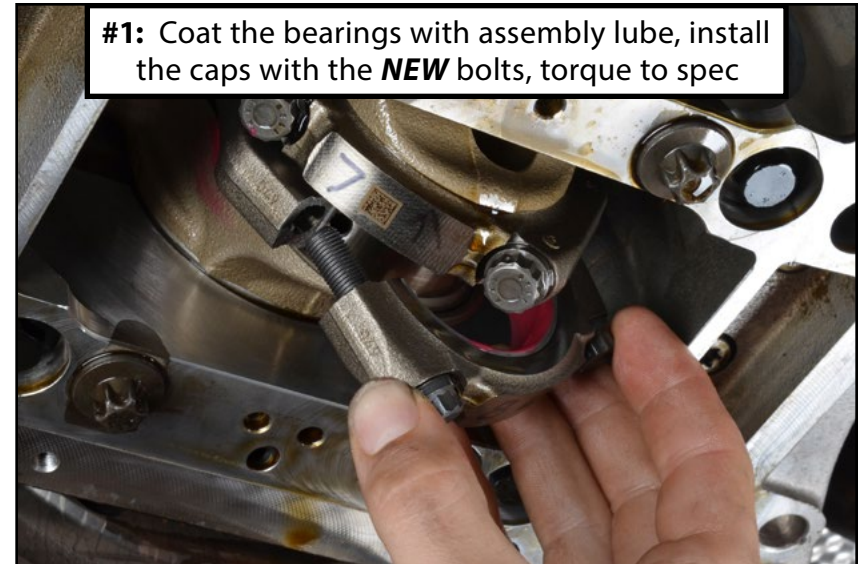

## REASSEMBLY PROCEDURE

### Step 1:

Now it's time to start reassembling the engine. Thoroughly clean the gasket surfaces on the engine block and oil sump (**photo #1**), we would suggest using a plastic scraper and brake cleaner for this. These are precision machined surfaces, *we don't want to risk damaging them with a metal scraper.*

Reinstall the bracket under the #7 & #8 connecting rods and the oil pickup tubes (**photo #2**). We would suggest applying **BLUE** thread locker to these bolts.

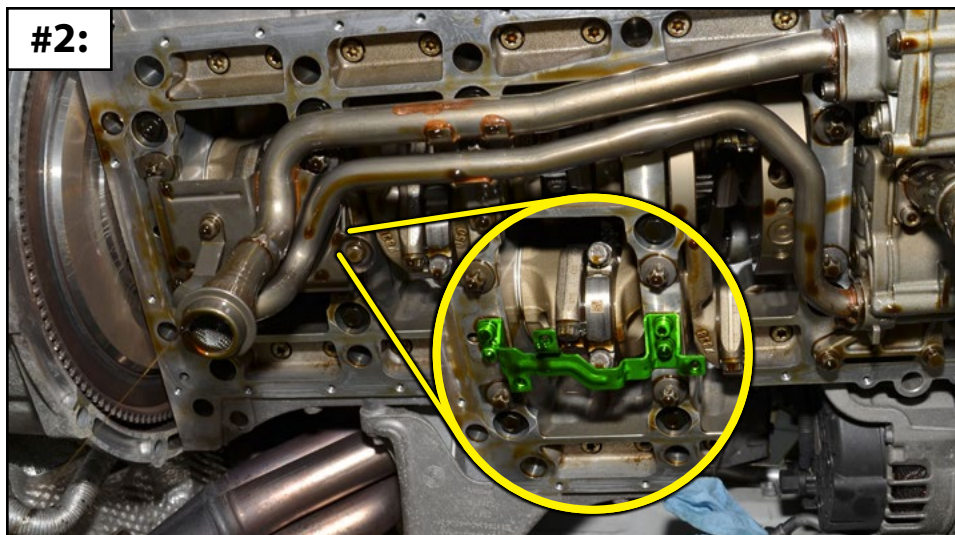
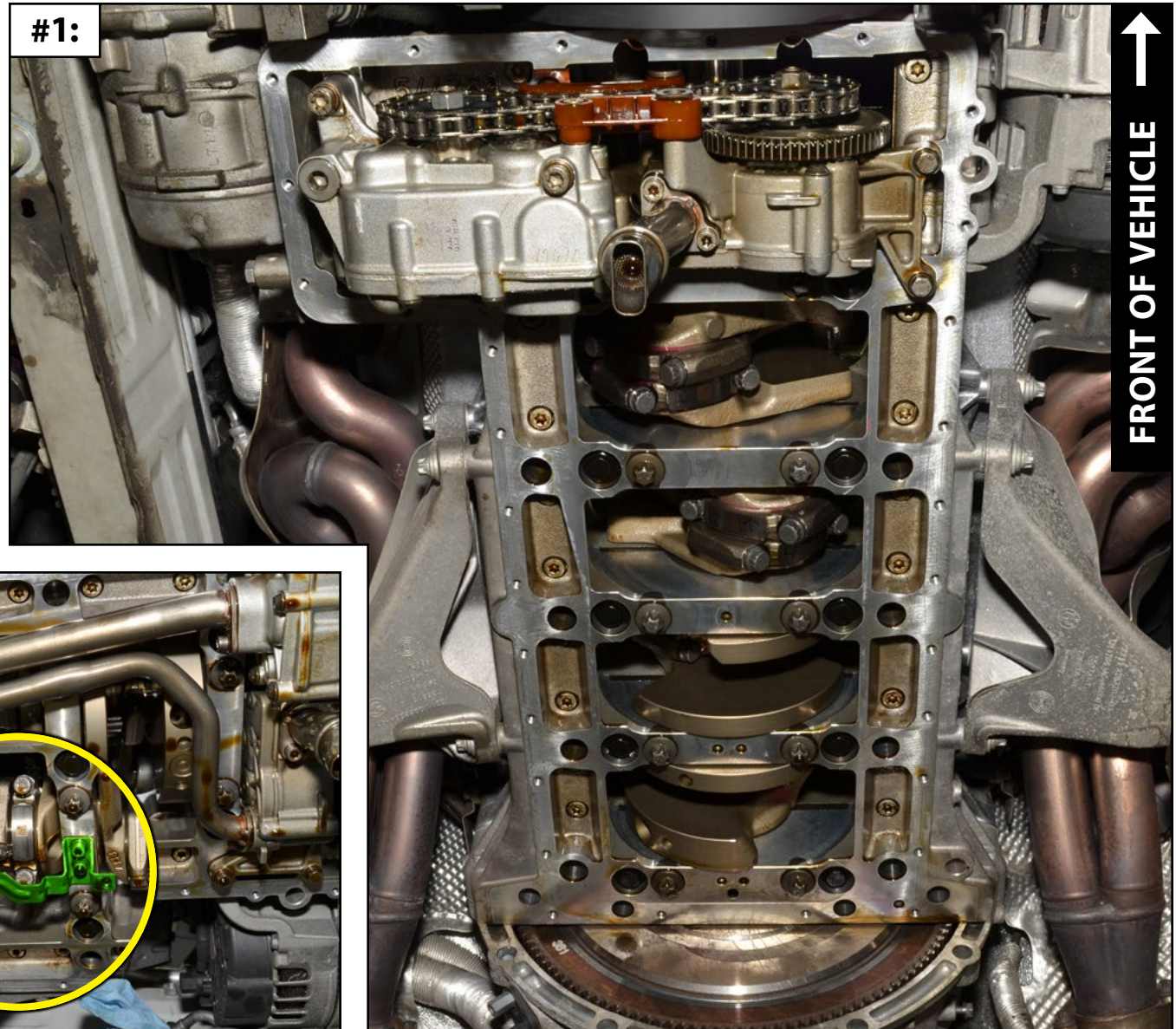

## REASSEMBLY PROCEDURE

### Step 2:

Reinstall the oil sump.

- All M6 screws: **10 Nm**

Reinstall the bell housing bolts.

- M8 bolts: **21 Nm**
- M10 bolts: **42 Nm**
- M12 bolts: **72 Nm**

Reinstall the A/C line bracket onto the oil sump.

Reinstall the ground cable onto the oil sump.

Reconnect the crankshaft position and oil level sensors.

Reinstall the O2 sensor wiring harness bracket.

Reinstall the A/C belt tensioner damper and bracket onto the oil sump.

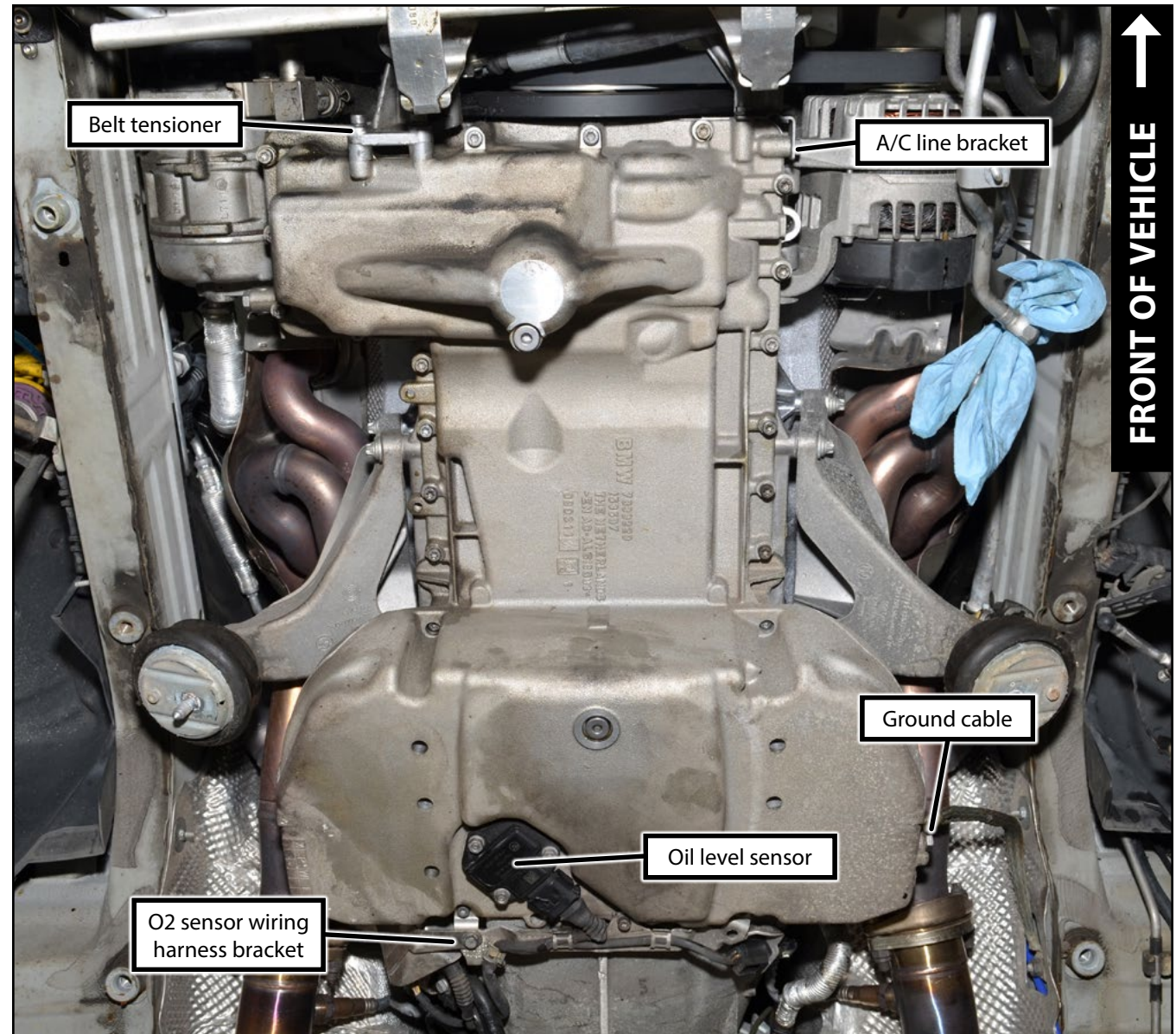

## REASSEMBLY PROCEDURE

### Step 3:

Reinstall the A/C belt.

There are two different belt routing options depending the build date of your vehicle.

We've included both diagrams on this page for you to reference.

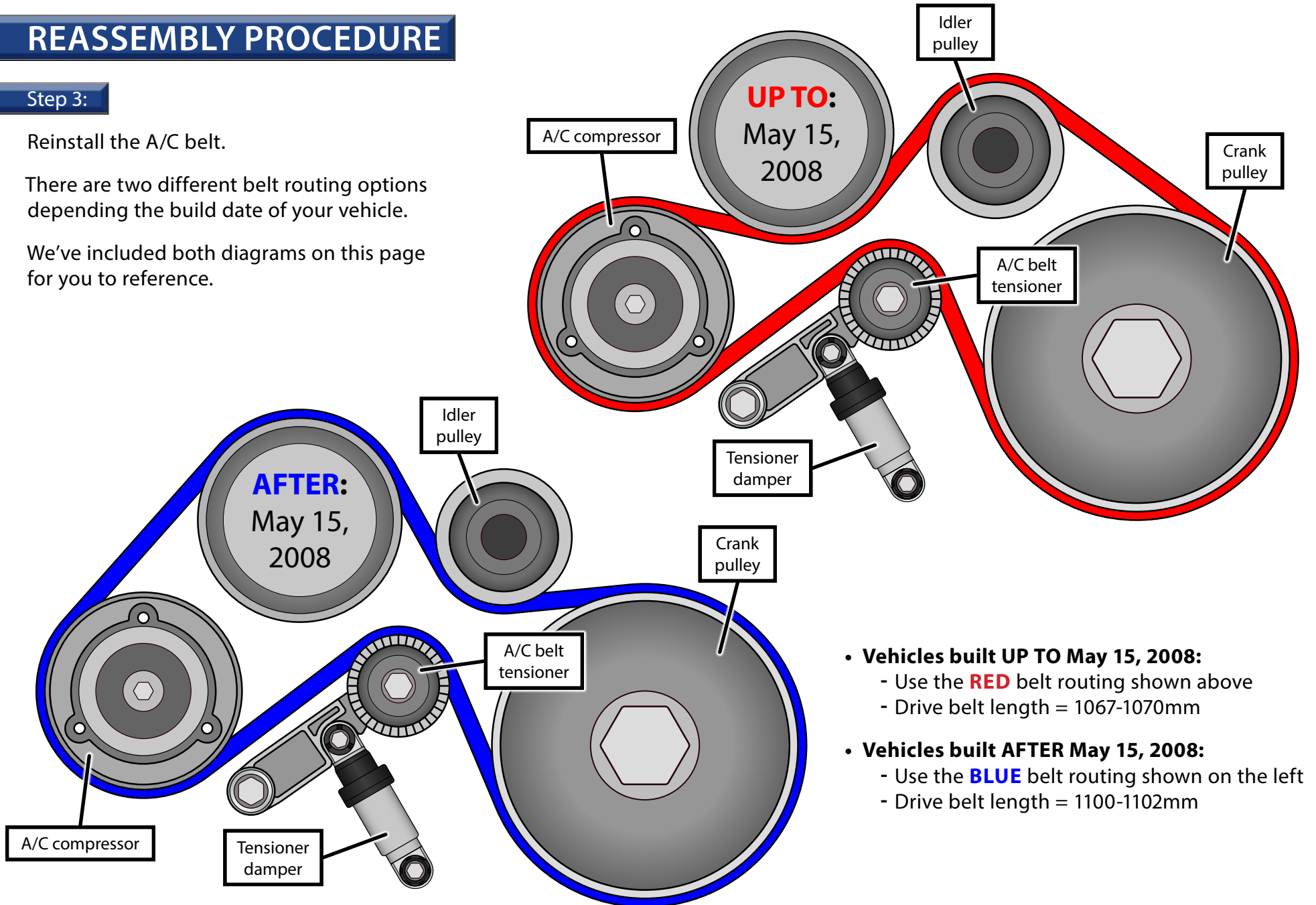

- **Vehicles built UP TO May 15, 2008:**
  - Use the **RED** belt routing shown above
  - Drive belt length = 1067-1070mm
- **Vehicles built AFTER May 15, 2008:**
  - Use the **BLUE** belt routing shown on the left
  - Drive belt length = 1100-1102mm



## REASSEMBLY PROCEDURE

### Step 4:

Reinstall the front subframe.

- M10 bolts: **56 Nm + 90°**
- M12 bolts: **108 Nm**

Reinstall the steering rack (*if removed*).

- M10 bolts: **56 Nm + 90°**

Lower the engine down until the engine mounts seat into the subframe.

Reinstall the engine mounts.

- M8 nuts: **28 Nm**
- M10 nuts: **38 Nm**

Remove the engine support bar.

Reconnect the power steering lines to the rack (*if removed*).

- M14 banjo bolt: **30 Nm**
- M16 banjo bolt: **35 Nm**

Reconnect the steering shaft u-joint to the rack.

- M8 bolt: **21 Nm**

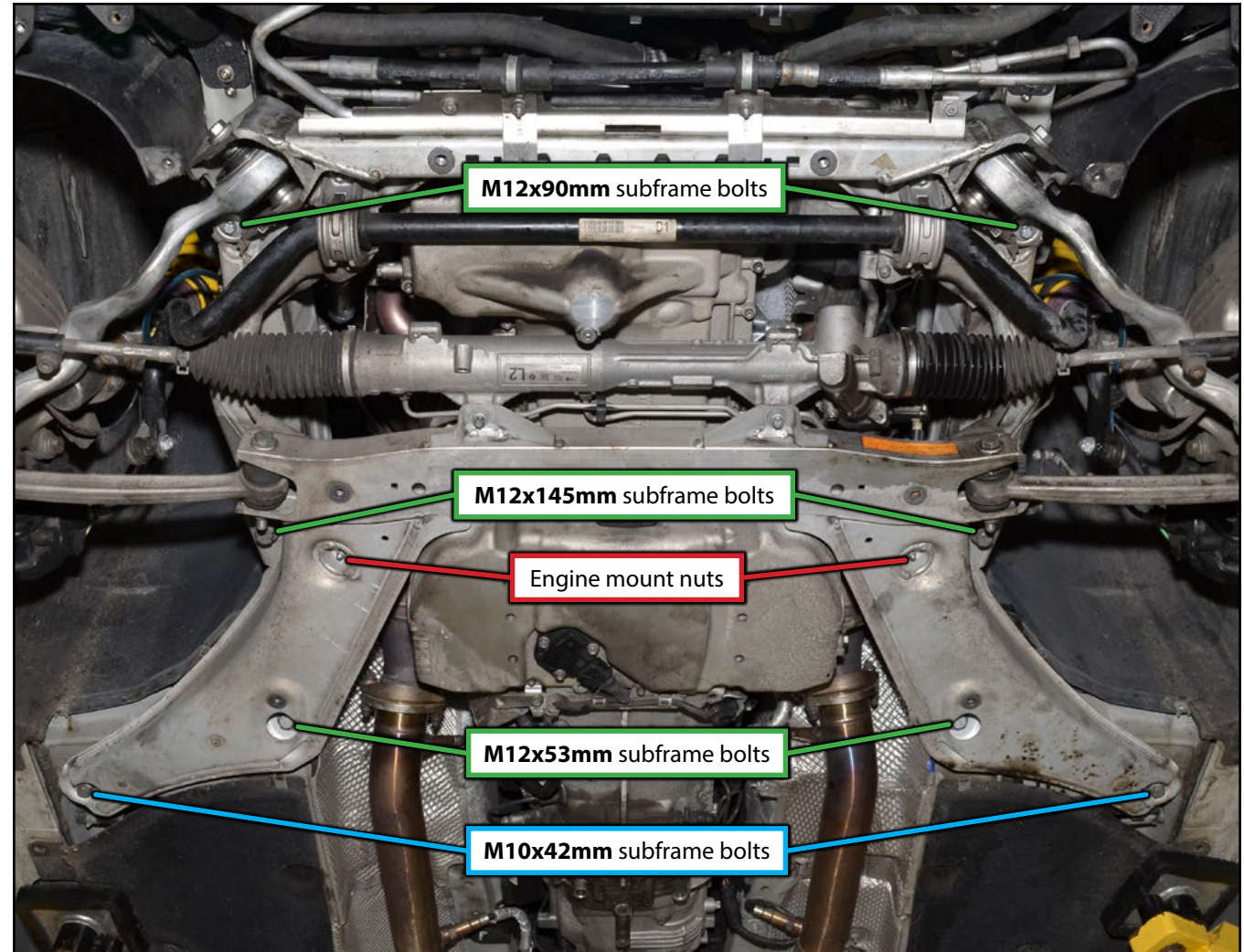

Reattach the hose set to the front of the subframe, and reattach the hard line to the subframe (10mm bolt near the LH sway bar bracket).

Reconnect the active steering electrical connector on the steering rack.

## REASSEMBLY PROCEDURE

### Step 5:

Reinstall the lower control arms.

- **78 Nm**

Reinstall the thrust arms (must be done w/the vehicle at ride height).

- M12 8.8 bolts: **56 Nm + 90°**
- M12 10.9 bolts: **100 Nm + 90°**

Reinstall the sway bar.

- Bracket nuts: **21 Nm**
- End link nuts: **58 Nm**

Reinstall the outer tie rod ends.

Reinstall the belly pans.



## REASSEMBLY PROCEDURE

### Step 6:

Reinstall the spark plugs.

Reinstall the coil packs, **but leave the electrical connectors detached for now.**

Remove the fuel pump fuse.

Reinstall the air box and inlet tube.

Reconnect the negative battery terminal.

Fill the engine oil to capacity.

Turn the ignition switch to "Crank" and let the engine turn over 5-10 seconds. This will allow the oil pressure to build without the engine needing to run.

Reconnect the coil pack electrical connectors, reinstall the coil pack covers, reinstall the fuel pump fuse.

Start the engine and listen for knocks.

Turn off the engine and check the oil level. Top off as needed.

Change the oil after 500 miles.



***Congratulations, your installation is complete!***

## Your S65 WPC Treated Rod Bearing Kit installation is complete!



### **These instructions are provided as a courtesy by Turner Motorsport**

Proper service and repair procedures are vital to the safe, reliable operation of all motor vehicles as well as the personal safety of those performing the repairs. Standard safety procedures and precautions (including use of safety goggles and proper tools and equipment) should be followed at all times to eliminate the possibility of personal injury or improper service which could damage the vehicle or compromise its safety.

Although this material has been prepared with the intent to provide reliable information, no warranty (express or implied) is made as to its accuracy or completeness. Neither is any liability assumed for loss or damage resulting from reliance on this material. SPECIFICALLY, NO WARRANTY OF MERCHANTABILITY, FITNESS FOR A PARTICULAR PURPOSE OR ANY OTHER WARRANTY IS MADE OR TO BE IMPLIED WITH RESPECT TO THIS MATERIAL. In no event will Turner Motorsport, Incorporated or its affiliates be liable for any damages, direct or indirect, consequential or compensatory, arising out of the use of this material.