

This is a supplement to the Audi 1.8T Ultimate Timing Belt Installation tutorial. Information in this document assists you in removing the front bumper/fascia and radiator support to gain access to the front of the engine.



Audi A4 1.8T Ultimate Timing Belt Kit Installation ES#8146

Procedure: Install ECS Tuning Ultimate Timing Belt Kit - P/N ES#8146

Application Notes: This kit fits A4 1.8T up to model year 2004 - up to VIN# 8E 4 191 000

Kit Contents:

- Timing belt
- Accessory drive belt
- Tensioner roller
- Camshaft seal
- Crankshaft seal
- Hydraulic tensioner assembly
- Metal impeller water pump
- Replacement TTY crankshaft bolt
- Crank pulley bolts (4)
- 2- 1.5 liter G12 coolant



This kit installation has been performed in-house at ECS Tuning, using our **Ultimate Plus Timing Belt Kit, ES#8146**. Getting dirty gives us hands on experience and let's us verify installation procedures. We experience issues you may encounter.

This is a supplement to the Audi 1.8T Ultimate Timing Belt Installation tutorial. Information in this document assists you in removing the front bumper/fascia and radiator support to gain access to the front of the engine.



This tutorial is provided as a courtesy by ECS Tuning.

Proper service and repair procedures are vital to the safe, reliable operation of all motor vehicles as well as the personal safety of those performing the repairs. Standard safety procedures and precautions (including use of safety goggles and proper tools and equipment) should be followed at all times to eliminate the possibility of personal injury or improper service which could damage the vehicle or compromise its safety.

Although this material has been prepared with the intent to provide reliable information, no warranty (express or implied) is made as to its accuracy or completeness. Neither is any liability assumed for loss or damage resulting from reliance on this material. SPECIFICALLY, NO WARRANTY OF MERCHANTABILITY, FITNESS FOR A PARTICULAR PURPOSE OR ANY OTHER WARRANTY IS MADE OR TO BE IMPLIED WITH RESPECT TO THIS MATERIAL. In no event will ECS Tuning, Incorporated or its affiliates be liable for any damages, direct or indirect, consequential or compensatory, arising out of the use of this material.

Safety First

Conventional wisdom says: Disconnect the battery before doing this repair. Our attorney agrees.

However...

Disconnecting the battery has a dark side you ought to know about. Doing so erases all volatile memory in your vehicle computer. This commonly includes electronic throttle control learned positions. Some vehicles will not idle following a power down until throttle position data are restored with a scan tool and the correct vehicle software.

Additionally, other driver preferences, antitheft radio code, radio presets and clock, and OBD II emissions data will be erased if battery power is removed. This is an important consideration if your vehicle is subject to a scan tool emissions test; erasing computer memory resets all OBD II monitors to incomplete, and your vehicle will not pass its emissions test until a global drive cycle completes all non-continuous monitors.

If you choose **NOT** to disconnect the battery, remove the ignition key and gather all copies of the ignition key and lock them away. Better still, mail them to yourself so nobody can crank over the engine or power up the ignition system until tomorrow's mail arrives. If you crank the engine over with the T-belt removed, **you will bend valves.**

Other Cautions

Work carefully to avoid damaging wires and connectors. Avoid any test procedure that damages wire insulation or creates a short circuit—to voltage, ground, or another circuit. Failure to follow these and all other safety precautions and approved shop practices can result in costly vehicle damage and serious personal injury.

Read the instructions completely before starting! Obtain all required tools. Reference factory repair instructions, when in doubt. If the installation procedures are beyond your tools and skills, contact a qualified installer for professional assistance.



Audi A4 1.8T Ultimate Timing Belt Kit Installation

ES#8146

Preparations

Tools Required:

- Drain pans for coolant and power steering fluid
- Assorted Torx® drivers
- Assorted Allen sockets
- Assorted sockets, including 17 mm for camshaft nut and 19 mm 12-point for crankshaft nut.
- 17 mm open end (Accessory belt tensioner)
- Torque wrench
- Snap ring pliers (or VW tool for tensioner pulley)

Tightening Torques

- Please see the accompanying timing belt installation pdf for bolt tightening specifications.

Special Notes

No radiator drain plug - remove ECT sensor from bottom hose or pull bottom hose.
No radiator hose clamps - release clip attachments

Audi A4 1.8T Ultimate Plus Timing Belt Kit Installation ES#8146

Audi A4 1.8T Supplement - Removing the Front Bumper & Radiator Support

This work sheet deals with removal of the front bumper and radiator support to provide access to the engine when replacing a timing belt and water pump with the engine installed in the vehicle.

This information does not apply to an engine removed from the vehicle.

For working on an engine while it is in the vehicle, two main options exist:

Option 1: Remove the bumper and radiator support entirely. This opens up the front end of the engine compartment, providing full access to the front of the engine.

Option 2: Use service bolts installed horizontally in special service holes in front end, one at each bumper shock attachment point. This allows you to unbolt the radiator support and slide it forward several inches, away from the engine. You get more elbow room, but not as much room as you get with Option 1.

Illustrations show major components and fasteners.

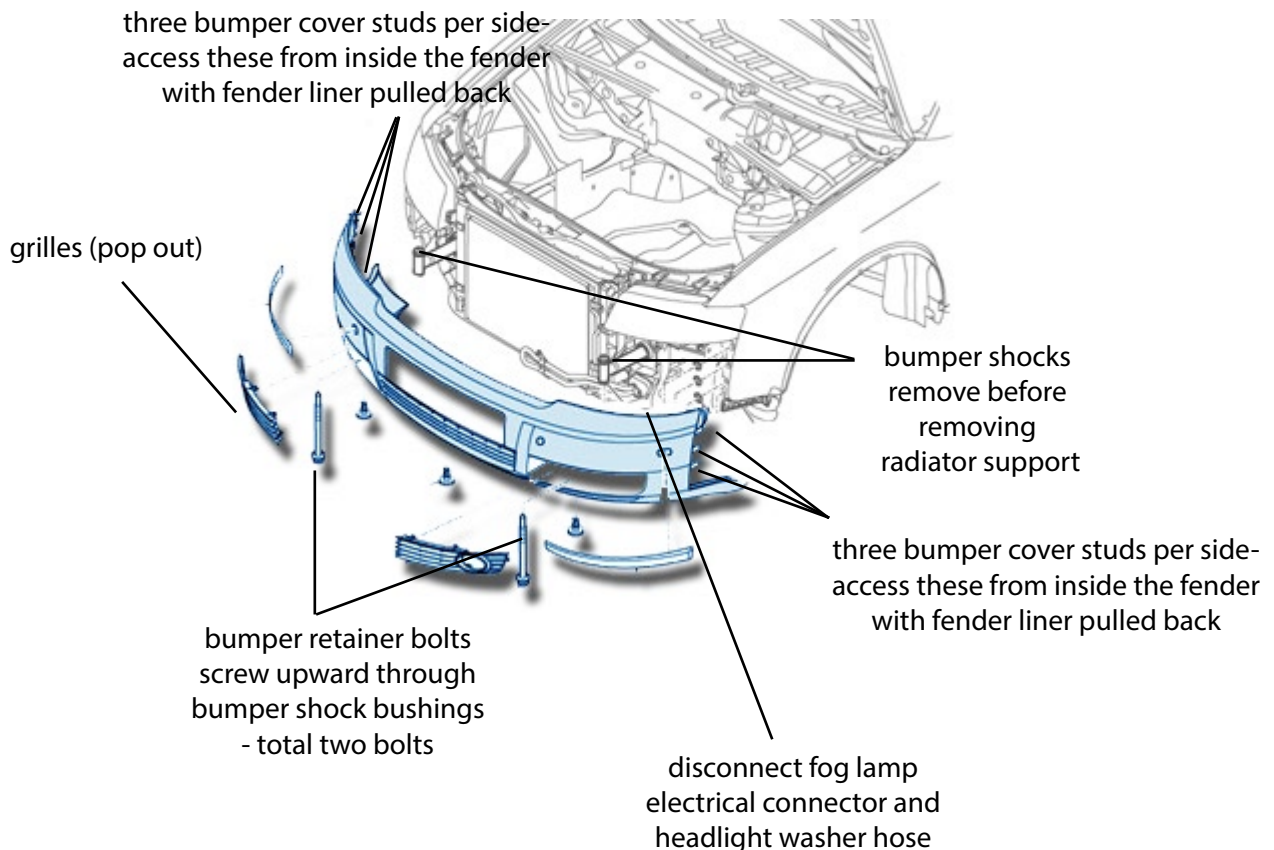

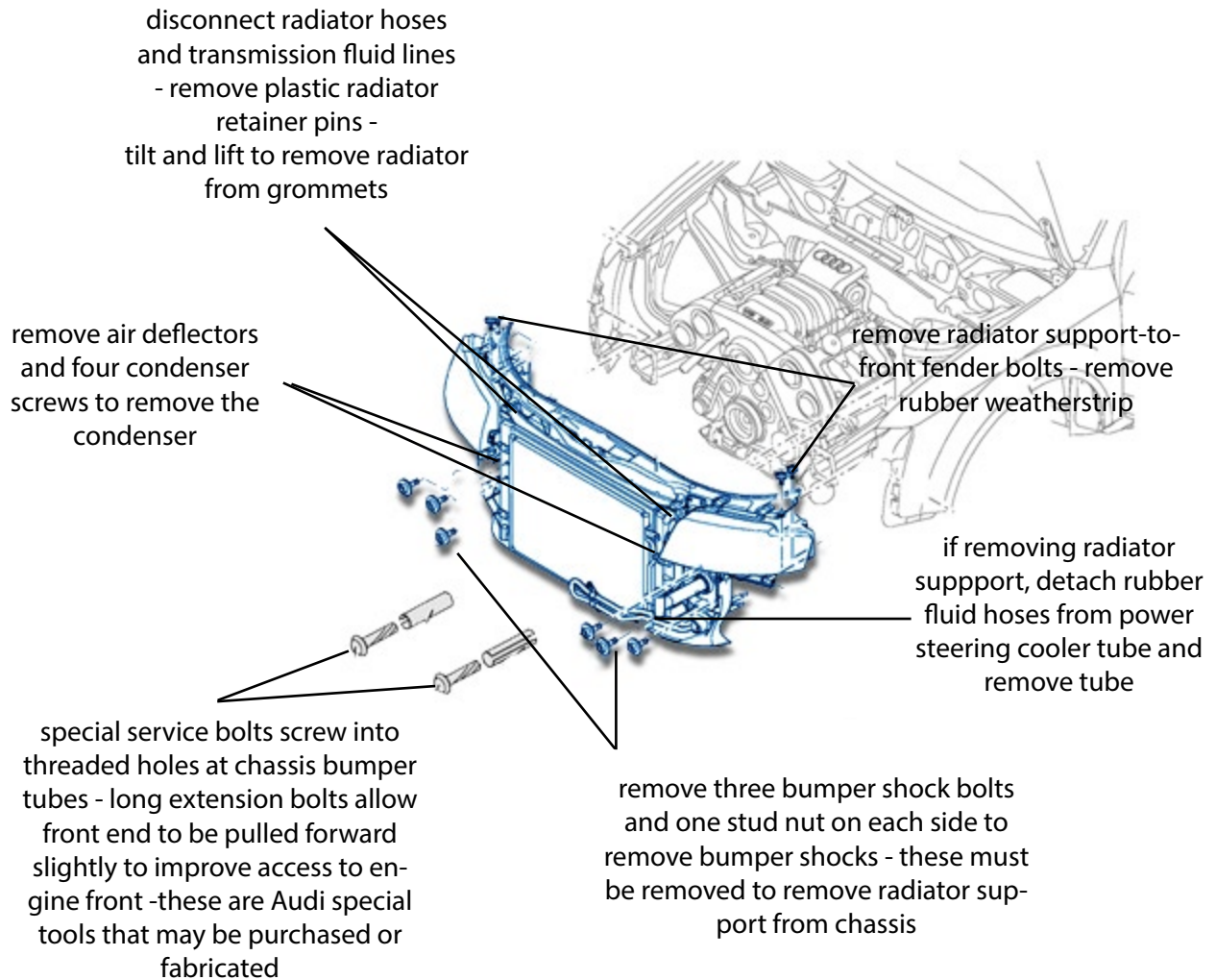

Photos and captions on the next few pages provide photo views of several components shown in the illustrations. In addition to these components, be prepared to disconnect all electrical connections for lights, cooling fans, etc. Treat older electrical connections with care; plastic connector lock clips get brittle with age, and break easily.

Audi A4 1.8T Ultimate Plus Timing Belt Kit Installation ES#8146



Tight fit? You bet. You can barely see the pavement below when peering down between the radiator support and front of the engine.



Not quite three fingers of clearance. Too tight to work.



To access and remove the nuts from the three threaded studs on each side of the bumper fascia, (where it joins the bumper), remove the lower retaining screw from each fender liner (arrow). Pull the liner back to expose the nuts, and remove them with a 10 mm socket.

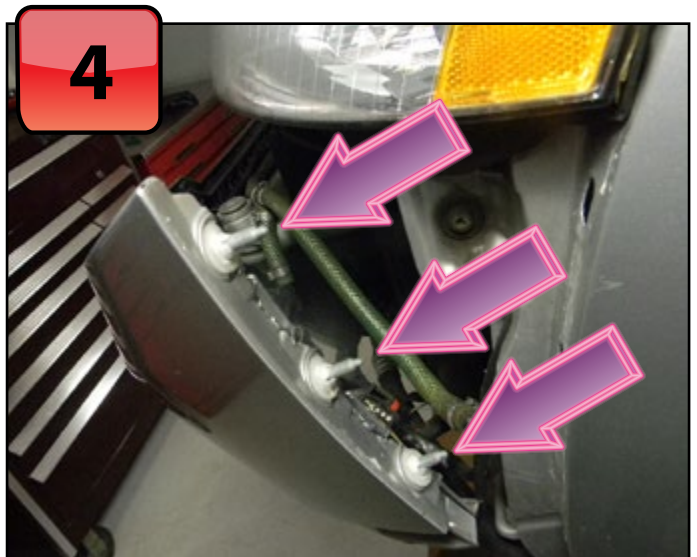

Here are the three attachment studs with the fascia pulled forward, away from the fender. (**Note:** You'll need to remove the bumper shock bolts before you can pull the fascia this far forward.) Disconnect the washer fluid line and electrical connections if the fascia is removed.

Audi A4 1.8T Ultimate Plus Timing Belt Kit Installation ES#8146



Removing the condenser side seals (top arrow) exposes the condenser retainer bolts. The lower arrow shows the location of bumper shock bolt hole. Remove these bolts (one on each side) from below after popping out the grilles. These are the main attachment points for the front bumper.

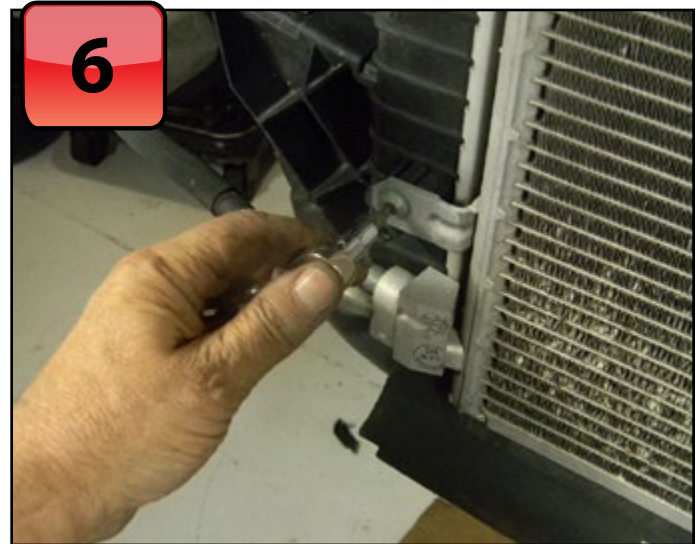

Remove the condenser Torx bolts. The condenser can be removed without disconnecting the air conditioning hoses. Hang the condenser from bungee cords beneath the car to prevent air conditioning hose damage.

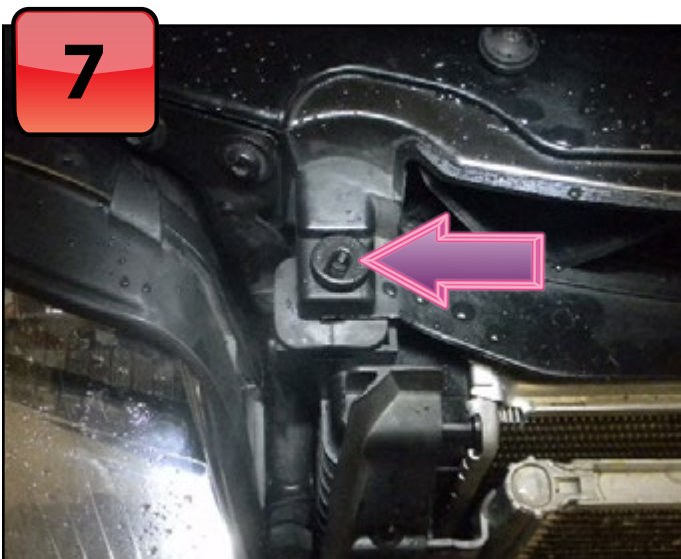

Push the center clip to one side to release the radiator retainer pins; lift up on the pins to remove them—one per side. The radiator sits in grommets in the radiator support panel.

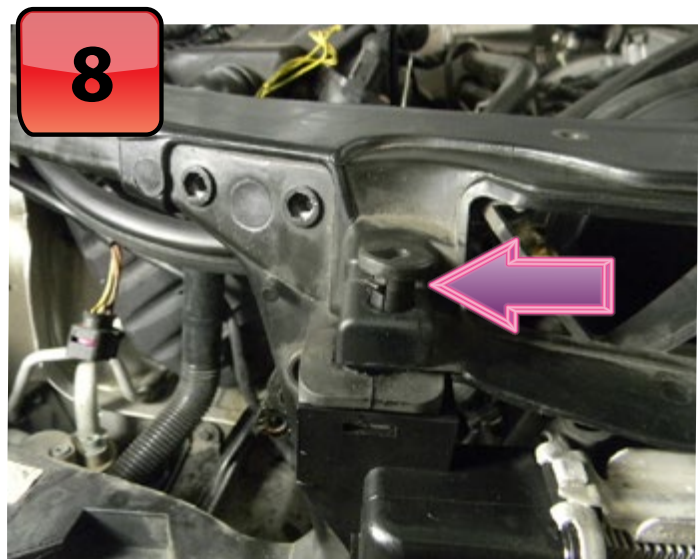

Here is a raised radiator clip, ready for removal. After removing both clips and disconnecting the radiator hoses and transmission cooler, tip the radiator forward and lift it out of the grommets.

Audi A4 1.8T Ultimate Plus Timing Belt Kit Installation ES#8146



There are no conventional screw-type hose clamps to remove. Instead, pry the radiator retainer wire clips upward to release them. Be prepared to pull hard to remove the hoses, even with the clips released, but be very careful not to damage any hose or radiator neck plastic pieces.

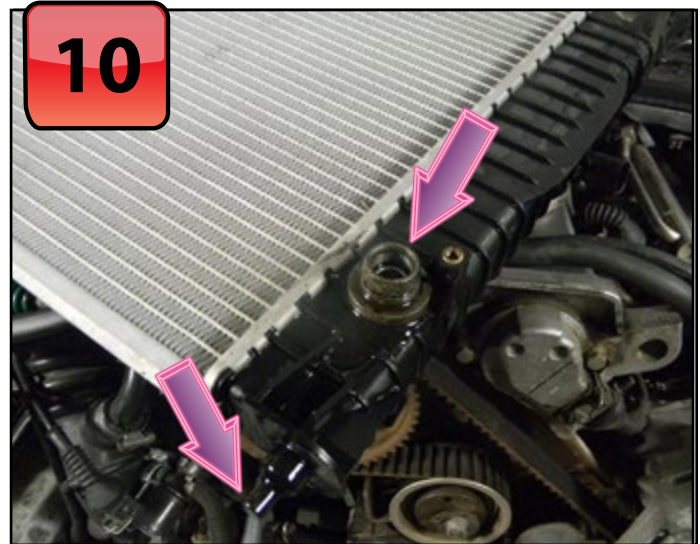

The top arrow shows one radiator coolant line attachment point. Both inlet and outlet transmission lines bolt to the radiator and seal with o-rings. The locator stud (bottom arrow) fits into rubber grommet in radiator support.

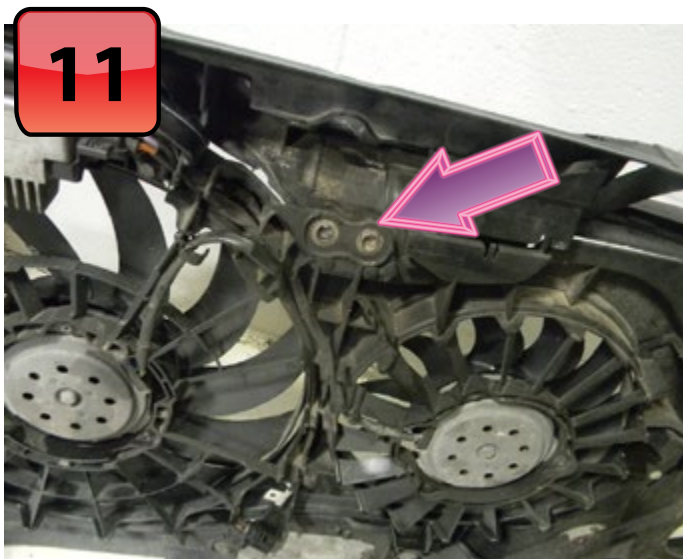

Here is the radiator support, removed from car. The arrow shows the location of the engine-side hood latch bolt holes; there two more on the opposite side. Remove all four bolts and the latch and lay it aside, before removing the radiator support. Disconnect or remove the crash sensors from support as well.

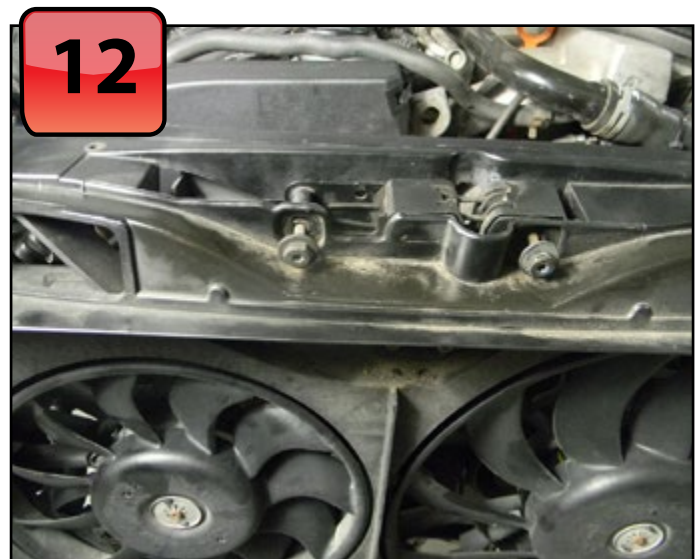

Here are the other two hood latch bolts, located on the front side of the radiator support.

Audi A4 1.8T Ultimate Plus Timing Belt Kit Installation ES#8146

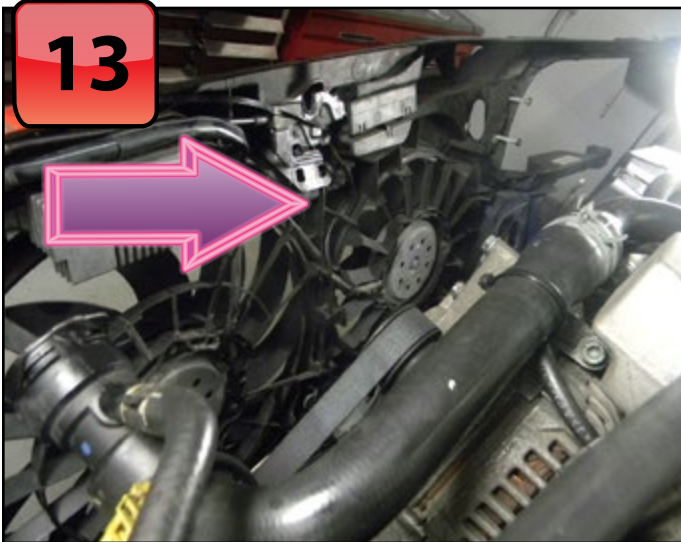

Don't forget to disconnect the hood latch sensor wire. It is hidden on the backside of the radiator header, between the fans. It's easy to miss. The wire snakes down to a connector near the bottom of the radiator support.

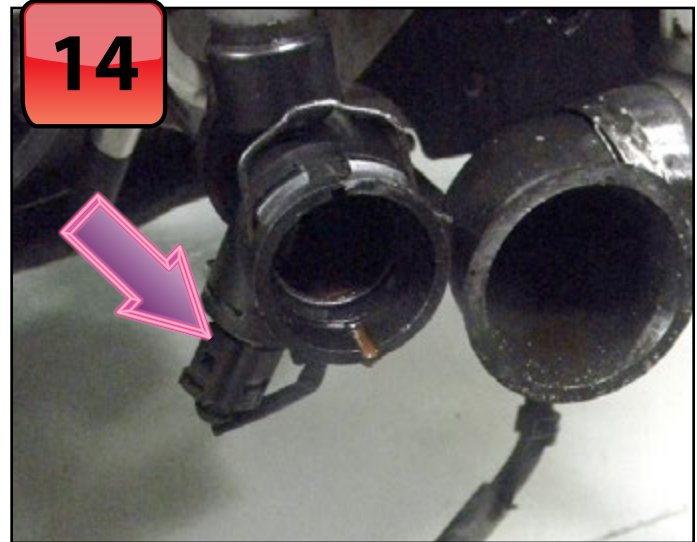

The lower radiator hose and air inlet hose for the charge air cooler must also be disconnected. There is no radiator drain plug. The coolant sensor may be disconnected and unscrewed to drain coolant—or just disconnect the lower radiator hose for the *express drain* feature!

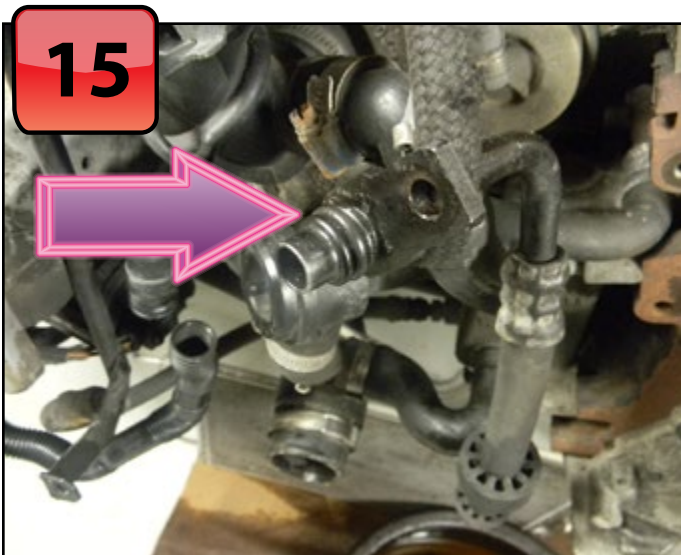

Check the transmission cooler line o-rings for damage. Note the location of the bolt hole for the attachment bracket.



Both crash sensors (one on either side of the radiator support) must be disconnected or unbolted and laid aside.

Audi A4 1.8T Ultimate Plus Timing Belt Kit Installation ES#8146



The crash sensors bolt to the radiator support with two Allen head screws. Our photo shows the bolt locations on the right side with the sensor already removed.

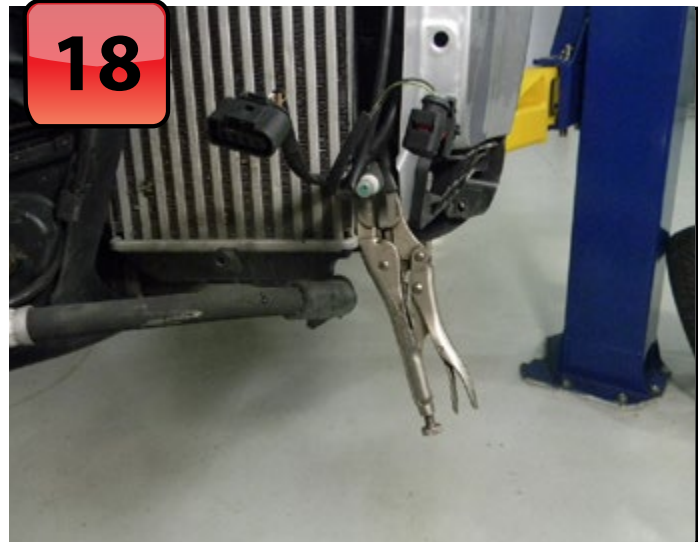

Pinch the washer fluid lines with soft-jawed pliers or a hose clamp. Slide two lengths of scrap rubber hose over the jaws of your needle-nosed vise grips to make a good hose clamp.

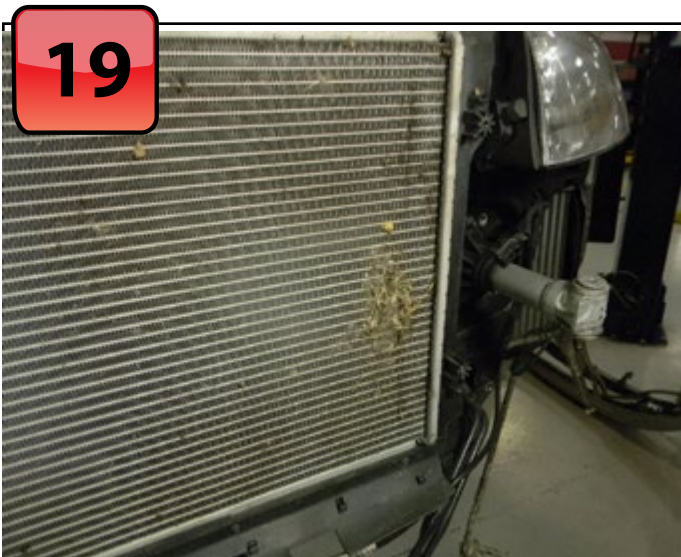

Gently clean away all accumulations of debris from the radiator and condenser. Use a soft bristle brush and low air pressure to dislodge leaves and grass, but be careful not to damage tubes or bend cooling fins.

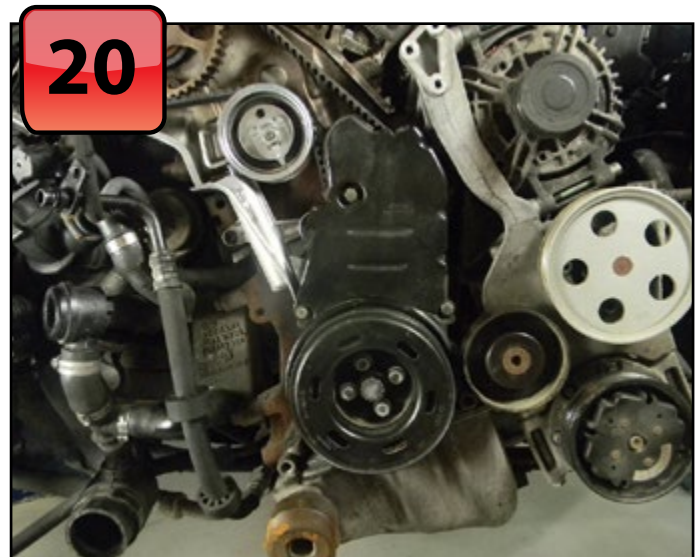

Please refer to the companion instruction sheet describing steps required to replace the T-belt and water pump in the Audi A4 1.8T.